

**D** Befestigungsmittel  
und Zubehör

**F** Accessoires

**E** Attachment  
Accessories and  
Clamps

## Unverzichtbar für jede Veranstaltung

- Befestigungsmittel
- Schäkkel
- Karabiner
- Schellen
- Rohrhaken
- Klemmen
- Klammern
- Ringmutter
- Seile
- Bodenspannleisten
- Beschwerungsrohre
- Verbindungsstifte
- Bühnen- und Bindebänder

## Moyens de fixation et accessoires

- Attaches
- Manilles
- Mousquetons
- Colliers
- Crochets de suspension
- Pinces
- Anneau de levage
- Drisses
- Profilés de tension sol
- Tubes de lestage
- Goujons de raccord
- Sangles et lacettes

## Useful Accessories

- Spannfix bungee hooks.
- Shackles.
- Carabiners.
- Couplers.
- Hook clamps.
- Clamps.
- Brackets.
- Eye bolts.
- Ropes.
- Mounting flange brackets for tensioning fabrics.
- Bottom weight pipes.
- Connection pins.
- Curtain tape and tie lines



## Auswahl aus unserem Zubehör

### 1 Half-Coupler und Swivel-Coupler

- Für Rohre Ø 30 - 51 mm.
- TÜV geprüft.
- Tragkraft 100 - 750 kg.

### 2 Doughty-HD-Trigger-Clamp

- Für Rohre Ø 38 - 51 mm.
  - TÜV geprüft.
  - Tragkraft: 100 kg.
- Rohrhaken
- Für Rohre Ø 48 - 60 mm.
  - Tragkraft: 100 kg.

### 3 Bodenspannleisten

- Zum Spannen und Fixieren von Folien und Tüchern mittels Klettband.
- Winkelstahl mit Holzbeplankung.
- Bodenspannleiste, gerade Länge: max. 6 m.
- Bodenspannleiste, gebogen Radius: min. 2 m. Abwicklungslänge max. 5,40 m.

### 4 Beschwerungsrohre, schraubbar

- Längen: 1 - 6 m, Sonderlängen auf Anfrage.
- Konische Trapezschraubverbindung.
- Abschlusskappen aus Kunststoff.
- In Stahl: Farbe schwarz, lackiert, Ø 28 x 2 mm.
- In Aluminium: Farbe natur, Ø 50 x 3 mm.

### 5 Satz Endkappen

- Abschlusskappen aus Kunststoff.
- Für Beschwerungsrohr Ø 28 mm und Ø 50 mm.
- Farbe: schwarz.

## Choix d'accessoires

### 1 Colliers simple et double

- Pour tube Ø 30 - 51 mm.
- Certifié TÜV.
- Charge 100 - 750 kg.

### 2 Collier simple HD DOUGHTY

- Pour tube Ø 38 - 51 mm.
  - Certifié TÜV.
  - Charge : 100 kg.
- Crochet de suspension
- Pour tube Ø 48 - 60 mm.
  - Charge : 100 kg.

### 3 Profilés de tension sol

- Pour fixer et tendre des toiles ou cyclos PVC par velcro.
- Profilé acier en L avec placage bois.
- Profilé de tension sol, droit, longueur : max. 6 m.
- Profilé de tension sol, cintré, rayon mini. de cintrage : 2 m. Développé max. : 5,40 m.

### 4 Tubes de lestage

- Longueurs : 1 - 6 m, longueurs spéciales sur demande.
- Raccord par vissage.
- Avec embouts plastique.
- En acier : coloris laqué noir, Ø 28 x 2 mm.
- En aluminium : coloris nature, Ø 50 x 3 mm.

### 5 Lot de 2 embouts

- Embouts en plastique.
- Pour tube de lestage Ø 28 mm et Ø 50 mm.
- Coloris : noir.

## Assorted Samples of our Accessories

### 1 Half-coupler and swivel-coupler

- For tubes Ø 1.18" - 2.00"
- TÜV certified.
- Load capacity 220 - 1,653 lbs.

### 2 Doughty-HD trigger clamp

- For tubes Ø 1.49" - 2.00"
  - TÜV certified.
  - Load capacity: 220 lbs.
- Hook clamps
- For tubes Ø 1.88" - 2.36"
  - Load capacity: 220 lbs.

### 3 Mounting flange brackets for tensioning fabrics

- For tensioning and fixing screens and cloth with Velcro® tape.
- Angle steel with wood.
- Mounting flange bracket, straight. Length: max. 19'8".
- Mounting flange bracket, curved. Radius: max. 6'7". Length: max. 17'7".

### 4 Bottom weight pipes, threaded connection

- Lengths: 3'3" - 19'8". Special lengths on request.
- Threaded connection.
- Plastic end caps.
- Available in steel: Black, varnished, 1.05" x 0.07".
- Available in Aluminum: Natural colour, 1.96" x 0.11".

### 5 Plastic End Caps

- For Bottom Weight Pipe Ø 28 mm and Ø 50 mm.
- Colour: black.



1



2



3

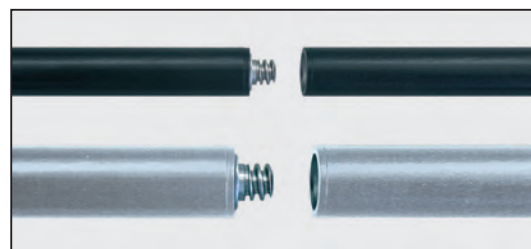

4

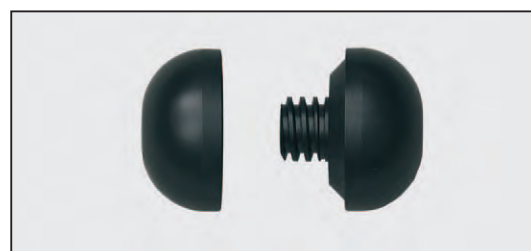

5

Fehler, Technische Änderungen und Irrtümer vorbehalten.  
 Sous réserve d'erreurs et de modifications techniques.  
 All information subject to change or technical modification without notice.

## Befestigungsmittel und Zubehör / Moyens de fixation et accessoires / Accessories and Hardware

| Spannfix            |           | Sandow            |            | Spannfix Bungee Cord |     |    |
|---------------------|-----------|-------------------|------------|----------------------|-----|----|
| Verpackungseinheit: | 100 Stück | Conditionnement : | 100 pièces | Pieces per box:      | 100 |    |
| Art. / Réf.         | Farben    | Coloris           | Colours    | B1 M1 EN NFPA        | g   | cm |
| 4107 0101           | weiß      | blanc             | white      |                      | 10  | 27 |
| 4107 0102           | schwarz   | noir              | black      |                      | 10  | 27 |

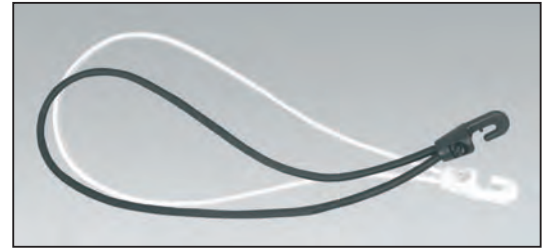

| Fastfix             |          | Sandow FASTFIX    |           | Fastfix Bungee Cord |    |    |
|---------------------|----------|-------------------|-----------|---------------------|----|----|
| Verpackungseinheit: | 50 Stück | Conditionnement : | 50 pièces | Pieces per box:     | 50 |    |
| Art. / Réf.         | Farben   | Coloris           | Colours   | B1 M1 EN NFPA       | g  | cm |
| 4107 0212           | schwarz  | noir              | black     |                     | 15 | 40 |



| Easyfix             |                           | Pince EASYFIX     |                                | Easyfix         |                               |    |
|---------------------|---------------------------|-------------------|--------------------------------|-----------------|-------------------------------|----|
| Material:           | Nylon, glasfaserverstärkt | Composition :     | nylon, renforcé fibre de verre | Material:       | Nylon, glass fiber reinforced |    |
| Verpackungseinheit: | 250 Stück                 | Conditionnement : | 250 pièces                     | Pieces per box: | 250                           |    |
| Art. / Réf.         | Farben                    | Coloris           | Colours                        | B1 M1 EN NFPA   | g                             | cm |
| 4107 0301           | weiß                      | blanc             | white                          |                 | 20                            | 8  |
| 4107 0302           | schwarz                   | noir              | black                          |                 | 20                            | 8  |



| Klemmfix    |              | Crochet rapide |               | Tube Clip      |               |    |
|-------------|--------------|----------------|---------------|----------------|---------------|----|
| Material:   | Polypropylen | Composition :  | polypropylène | Material:      | Polypropylene |    |
| Tragkraft:  | 40 kg        | Charge :       | 40 kg         | Load Capacity: | 40 kg         |    |
| Art. / Réf. | Farben       | Coloris        | Colours       | B1 M1 EN NFPA  | g             | cm |
| 4107 0402   | schwarz      | noir           | black         |                | 45            |    |



| Klemmschloss-Zurrgurt                         |           | Sangle d'arrimage                                       |           | Camlock Strap                           |           |    |
|---|-----------|---|-----------|---|-----------|----|
| Material:                                     | Polyester | Composition :   | polyester | Material:                               | Polyester |    |
| Ideal zur Höhenjustierung von Hauptvorhängen. |           | Se prête bien pour l'ajustement d'un rideau en hauteur. |           | For height adjustment of main curtains. |           |    |
| Art. / Réf.                                   | Farben    | Coloris   | Colours   | B1 M1 EN NFPA                           | cm        | cm |
| 4107 0602                                     | schwarz   | noir  | black     |   | 1,8       | 80 |



## Befestigungsmittel und Zubehör / Moyens de fixation et accessoires / Accessories and Hardware

### G-QUICK

Tragkraft: 3 kg  
 Verpackungseinheiten:  
 4107 1991/-1992 99 St. schwarz  
 1 St. rot

Zur Befestigung von geösten  
 Vorhängen und Prospekten.  
 Wahlweise mit rotem Verschluss zur  
 Mittenmarkierung.

### G-QUICK

Charge : 3 kg  
 Conditionnement :  
 4107 1991/-1992 99 pièces noir  
 1 pièce rouge

Pour une suspension rapide de  
 rideaux et PVCs de projection  
 œillettés.  
 Disponible également avec fermeture  
 rouge pour repérage du milieu.

### G-QUICK

Load Capacity: 3 kg  
 Pieces per box:  
 4107 1991/-1992 99 black  
 1 red

For attaching grommeted draperies  
 to pipe battens.  
 Available with a red ball to denote  
 center position of drape.



Für Laststangen / Pour porteuse / For flying bars: Ø 50 - 60 mm

| Art. / Réf. | Farben        | Coloris      | Colours     | B1 M1 EN NFPA | g  | cm |
|-------------|---------------|--------------|-------------|---------------|----|----|
| 4107 1001   | schwarz       | noir         | black       |               | 39 | 17 |
| 4107 1011   | rot           | rouge        | red         |               | 39 | 17 |
| 4107 1991   | schwarz / rot | noir / rouge | black / red |               | 39 | 17 |



Für Laststangen / Pour porteuse / For flying bars: Ø 70 - 80 mm

| Art. / Réf. | Farben        | Coloris      | Colours     | B1 M1 EN NFPA | g  | cm |
|-------------|---------------|--------------|-------------|---------------|----|----|
| 4107 1002   | schwarz       | noir         | black       |               | 42 | 22 |
| 4107 1012   | rot           | rouge        | red         |               | 42 | 22 |
| 4107 1992   | schwarz / rot | noir / rouge | black / red |               | 42 | 22 |



### G-CABLE

Verpackungseinheiten: 50 Stück

### G-CABLE

Conditionnement : 50 pièces

### G-CABLE

Pieces per box: 50

Für Laststangen / Pour porteuse / For flying bars: Ø 50 - 60 mm

| Art. / Réf. | Farben  | Coloris | Colours | B1 M1 EN NFPA | g  | cm |
|-------------|---------|---------|---------|---------------|----|----|
| 4107 1021   | schwarz | noir    | black   |               | 16 | 17 |



Für Laststangen / Pour porteuse / For flying bars: Ø 70 - 80 mm

| Art. / Réf. | Farben  | Coloris | Colours | B1 M1 EN NFPA | g  | cm |
|-------------|---------|---------|---------|---------------|----|----|
| 4107 1022   | schwarz | noir    | black   |               | 24 | 22 |

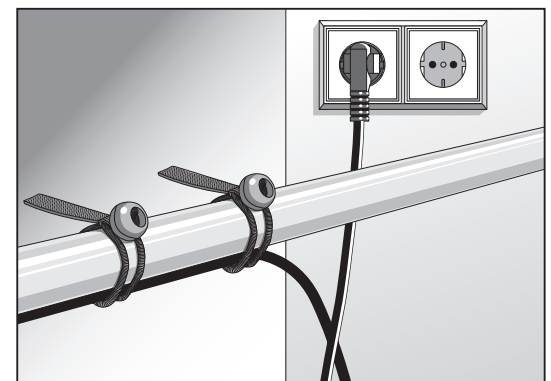

## Befestigungsmittel und Zubehör / Moyens de fixation et accessoires / Accessories and Hardware

### Schäkel

- Material M4 V2A Stahl.
- Mit Schlitzschrauben-Bolzen.

### Manille

- Matériau : acier inox M4 V2A.
- Avec boulon.

### Shackle

- Material M4 V2A steel.
- With bolt.

| Art. / Réf.      | Farbe  | Coloris | Colour |                                      | mm | g  |
|------------------|--------|---------|--------|--------------------------------------|----|----|
| <b>4302 0501</b> | silber | argent  | silver | Maße /<br>Dimensions /<br>Dimensions | 25 | 5  |
| <b>4302 0502</b> | silber | argent  | silver |                                      | 45 | 17 |

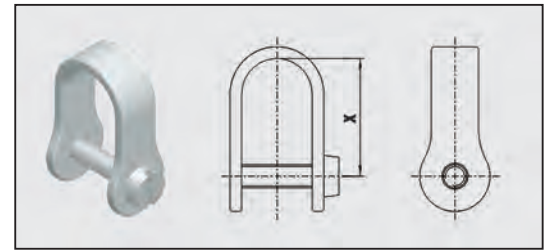

### Karabiner

- Feder- und Schraubverschluss.
- Federverschluss.
- Schraubverschluss.

### Mousquetons

- Mousqueton.
- Mousqueton.
- Maillon rapide.

### Carabiner

- Clip + threaded locking.
- Clip locking.
- Threaded locking.

| Art. / Réf.      | Farbe  | Coloris | Colour |                                      | mm     | g  |
|------------------|--------|---------|--------|--------------------------------------|--------|----|
| <b>4302 0601</b> | silber | argent  | silver | Maße /<br>Dimensions /<br>Dimensions | 80 / 8 | 30 |
| <b>4302 0602</b> | silber | argent  | silver |                                      | 60 / 6 | 28 |
| <b>4302 0603</b> | silber | argent  | silver |                                      | 57 / 5 | 34 |



Befestigungsmittel und Zubehör / Moyens de fixation et accessoires / Accessories and Hardware

9

**Doughty-Half-Coupler, 75 kg**

- Einfachschele.
- Für Rohr Ø 48 - 51 mm.
- Fixings: M10.
- TÜV geprüft.

**Collier simple DOUGHTY, 75 kg**

- Pour tube Ø 48 - 51 mm.
- Pour boulons M10.
- Certifié TÜV.

**Doughty-Half-Coupler, 75 kg**

- Single coupler.
- For pipe Ø 48 - 51 mm.
- Fixings: M10.
- TÜV certified.

| Art. / Réf.      | Farbe | Coloris | Colour   | mm                                | g   |
|------------------|-------|---------|----------|-----------------------------------|-----|
| <b>4302 0113</b> | alu   | alu     | aluminum | Breite /<br>Largeur /<br>Width 32 | 180 |



**Half-Coupler, 100 kg**

- Einfachschele.
- Für Rohr Ø 48 - 51 mm.
- Fixings: M10.
- TÜV geprüft.

**Collier simple, 100 kg**

- Pour tube Ø 48 - 51 mm.
- Pour boulons M10.
- Certifié TÜV.

**Half-Coupler, 100 kg**

- Single coupler.
- For pipe Ø 48 - 51 mm.
- Fixings: M10.
- TÜV certified.

| Art. / Réf.      | Farbe   | Coloris | Colour   | mm                                | g   |
|------------------|---------|---------|----------|-----------------------------------|-----|
| <b>4302 0116</b> | alu     | alu     | aluminum | Breite /<br>Largeur /<br>Width 30 | 150 |
| <b>4302 0117</b> | schwarz | noir    | black    | 30                                | 150 |



**Half-Coupler ECO, 100 kg**

- Einfachschele.
- Für Rohr Ø 48 - 51 mm.
- Fixings: M10.
- Ohne TÜV.

**Collier simple ECO, 100 kg**

- Pour tube Ø 48 - 51 mm.
- Pour boulons M10.
- Non certifié TÜV.

**Half-Coupler ECO, 100 kg**

- Single coupler.
- For pipe Ø 48 - 51 mm.
- Fixings: M10.
- Without TÜV.

| Art. / Réf.      | Farbe | Coloris | Colour   | mm                                | g   |
|------------------|-------|---------|----------|-----------------------------------|-----|
| <b>4302 0114</b> | alu   | alu     | aluminum | Breite /<br>Largeur /<br>Width 30 | 140 |

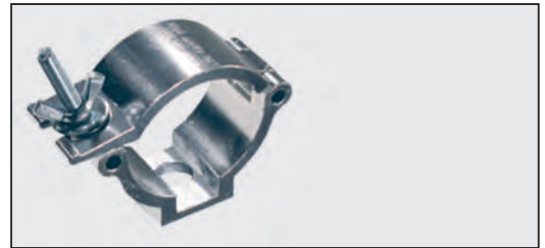

**Doughty-Half-Coupler, 300 kg**

- Einfachschele.
- Für Rohr Ø 48 - 51 mm.
- Fixings: M12.
- TÜV geprüft.

**Collier simple DOUGHTY, 300 kg**

- Pour tube Ø 48 - 51 mm.
- Pour boulons M12.
- Certifié TÜV.

**Doughty-Half-Coupler, 300 kg**

- Single coupler.
- For pipe Ø 48 - 51 mm.
- Fixings: M12.
- TÜV certified.

| Art. / Réf.      | Farbe | Coloris | Colour   | mm                                | g   |
|------------------|-------|---------|----------|-----------------------------------|-----|
| <b>4302 0111</b> | alu   | alu     | aluminum | Breite /<br>Largeur /<br>Width 30 | 320 |



**Half-Coupler ECO, 500 kg**

- Einfachschele.
- Für Rohr Ø 48 - 51 mm.
- Fixings: M12.
- Ohne TÜV.

**Collier simple ECO, 500 kg**

- Pour tube Ø 48 - 51 mm.
- Pour boulons M12.
- Non certifié TÜV.

**Half-Coupler ECO, 500 kg**

- Single coupler.
- For pipe Ø 48 - 51 mm.
- Fixings: M12.
- Without TÜV.

| Art. / Réf.      | Farbe | Coloris | Colour   | mm                                | g   |
|------------------|-------|---------|----------|-----------------------------------|-----|
| <b>4302 0115</b> | alu   | alu     | aluminum | Breite /<br>Largeur /<br>Width 50 | 460 |



## Befestigungsmittel und Zubehör / Moyens de fixation et accessoires / Accessories and Hardware

### Doughty-Half-Coupler, 500 kg

- Einfachschele.
- Für Rohr Ø 48 - 51 mm.
- Fixings: M12.
- TÜV geprüft.

### Collier simple DOUGHTY, 500 kg

- Pour tube Ø 48 - 51 mm.
- Pour boulons M12.
- Certifié TÜV.

### Doughty-Half-Coupler, 500 kg

- Single coupler.
- For pipe Ø 48 - 51 mm.
- Fixings: M12.
- TÜV certified.

| Art. / Réf.      | Farbe | Coloris | Colour   | mm                                | g   |
|------------------|-------|---------|----------|-----------------------------------|-----|
| <b>4302 0101</b> | alu   | alu     | aluminum | Breite /<br>Largeur /<br>Width 50 | 340 |



### Half-Coupler, 500 kg

- Einfachschele.
- Für Rohr Ø 48 - 51 mm.
- Fixings: M12.
- TÜV geprüft.

### Collier simple, 500 kg

- Pour tube Ø 48 - 51 mm.
- Pour boulons M12.
- Certifié TÜV.

### Half-Coupler, 500 kg

- Single coupler.
- For pipe Ø 48 - 51 mm.
- Fixings: M12.
- TÜV certified.

| Art. / Réf.      | Farbe   | Coloris | Colour   | mm                                | g   |
|------------------|---------|---------|----------|-----------------------------------|-----|
| <b>4302 0118</b> | alu     | alu     | aluminum | Breite /<br>Largeur /<br>Width 50 | 531 |
| <b>4302 0119</b> | schwarz | noir    | black    | 50                                | 531 |



### Doughty-Swivel-Coupler, 500 kg

- Doppelschele.
- 360° drehbar.
- Für Rohr Ø 48 - 51 mm.
- TÜV geprüft.

### Collier double DOUGHTY, 500 kg

- Pivotant 360°.
- Pour tube Ø 48 - 51 mm.
- Certifié TÜV.

### Doughty-Swivel-Coupler, 500 kg

- Double coupler.
- 360° swivel.
- For pipe Ø 48 - 51 mm.
- TÜV certified.

| Art. / Réf.      | Farbe | Coloris | Colour   | mm                                | g   |
|------------------|-------|---------|----------|-----------------------------------|-----|
| <b>4302 0107</b> | alu   | alu     | aluminum | Breite /<br>Largeur /<br>Width 50 | 760 |



### Doughty-Half-Coupler, 750 kg

- Einfachschele.
- Für Rohr Ø 48 - 51 mm.
- Fixings: M12.
- TÜV geprüft.

### Collier simple DOUGHTY, 750 kg

- Pour tube Ø 48 - 51 mm.
- Pour boulons M12.
- Certifié TÜV.

### Doughty-Half-Coupler, 750 kg

- Single coupler.
- For pipe Ø 48 - 51 mm.
- Fixings: M12.
- TÜV certified.

| Art. / Réf.      | Farbe | Coloris | Colour   | mm                                | g   |
|------------------|-------|---------|----------|-----------------------------------|-----|
| <b>4302 0102</b> | alu   | alu     | aluminum | Breite /<br>Largeur /<br>Width 30 | 410 |



### Doughty-Half-Coupler, 750 kg

- Einfachschele.
- Für Rohr Ø 48 - 51 mm.
- Fixings: M12.
- TÜV geprüft.

### Collier simple DOUGHTY, 750 kg

- Pour tube Ø 48 - 51 mm.
- Pour boulons M12.
- Certifié TÜV.

### Doughty-Half-Coupler, 750 kg

- Single coupler.
- For pipe Ø 48 - 51 mm.
- Fixings: M12.
- TÜV certified.

| Art. / Réf.      | Farbe | Coloris | Colour   | mm                                | g   |
|------------------|-------|---------|----------|-----------------------------------|-----|
| <b>4302 0112</b> | alu   | alu     | aluminum | Breite /<br>Largeur /<br>Width 50 | 630 |



## Befestigungsmittel und Zubehör / Moyens de fixation et accessoires / Accessories and Hardware

9

### Doughty-Swivel-Coupler, 750 kg

- Doppelschelle.
- 360° drehbar.
- Für Rohr Ø 48 - 51 mm.
- TÜV geprüft.

### Collier double DOUGHTY, 750 kg

- Pivotant 360°.
- Pour tube Ø 48 - 51 mm.
- Certifié TÜV.

### Doughty-Swivel-Coupler, 750 kg

- Double coupler.
- 360° swivel.
- For pipe Ø 48 - 51 mm.
- TÜV certified.

| Art. / Réf.      | Farbe | Coloris | Colour   | mm                                | g    |
|------------------|-------|---------|----------|-----------------------------------|------|
| <b>4302 0106</b> | alu   | alu     | aluminum | Breite /<br>Largeur /<br>Width 50 | 1330 |



### Doughty-Half-Coupler, 500 kg

- Einfachschelle.
- Für Rohr Ø 60 - 63 mm.
- Fixings: M12.
- TÜV geprüft.

### Collier simple DOUGHTY, 500 kg

- Pour tube Ø 60 - 63 mm.
- Pour boulons M12.
- Certifié TÜV.

### Doughty-Half-Coupler, 500 kg

- Single coupler.
- For pipe Ø 60 - 63 mm.
- Fixings: M12.
- TÜV certified.

| Art. / Réf.      | Farbe   | Coloris | Colour | mm                                | g   |
|------------------|---------|---------|--------|-----------------------------------|-----|
| <b>4302 0110</b> | schwarz | noir    | black  | Breite /<br>Largeur /<br>Width 50 | 410 |



### Doughty-Slimline-Trigger-Clamp

- Für Rohr Ø 38 - 51 mm.
- TÜV geprüft.
- Tragkraft: 200 kg.

### Collier simple DOUGHTY

- Pour tube Ø 38 - 51 mm.
- Certifié TÜV.
- Charge : 200 kg.

### Doughty-Slimline-Trigger-Clamp

- For pipe Ø 38 - 51 mm.
- TÜV certified.
- Load Capacity: 200 kg.

| Art. / Réf.      | Farbe   | Coloris | Colour | mm                                | g   |
|------------------|---------|---------|--------|-----------------------------------|-----|
| <b>4302 0109</b> | schwarz | noir    | black  | Breite /<br>Largeur /<br>Width 30 | 490 |



### Slimline-Trigger-Clamp

- Für Rohr Ø 48 - 51 mm.
- Fixings: M12.
- TÜV geprüft.
- Tragkraft: 250 kg.

### Collier simple HD

- Pour tube Ø 48 - 51 mm.
- Pour boulons M12.
- Certifié TÜV.
- Charge : 250 kg.

### Slimline-Trigger-Clamp

- For pipe Ø 48 - 51 mm.
- Fixings: M12.
- TÜV certified.
- Load Capacity: 250 kg.

| Art. / Réf.      | Farbe   | Coloris | Colour   | mm                    | g      |
|------------------|---------|---------|----------|-----------------------|--------|
| <b>4302 0120</b> | alu     | alu     | aluminum | Breite /              | 30 471 |
| <b>4302 0121</b> | schwarz | noir    | black    | Largeur /<br>Width 30 | 471    |



### Rohrhaken

- Für Rohr Ø 48 - 60 mm.
- Tragkraft: 100 kg.

### Crochet de suspension

- Pour tube Ø 48 - 60 mm.
- Charge : 100 kg.

### Hook Clamp

- For pipe Ø 48 - 60 mm.
- Load Capacity: 100 kg.

| Art. / Réf.      | Farbe   | Coloris | Colour | mm                                | g   |
|------------------|---------|---------|--------|-----------------------------------|-----|
| <b>4302 0201</b> | schwarz | noir    | black  | Breite /<br>Largeur /<br>Width 42 | 585 |





## Befestigungsmittel und Zubehör / Moyens de fixation et accessoires / Accessories and Hardware

### ERICO-Trägerklemme

- Zur Direktmontage an Stahlbauträgern mit Gewindestange M12 3130 8051.
- Klemmbereich: 2 - 20 mm.

### Bride ERICO

- Pour montage direct du rail sur poutres acier en combinaison avec tige filetée M12 3130 8051.
- Réglage : 2 - 20 mm.

### ERICO Beam Clamp

- For direct steel beam mounting via M12 threaded bolt 3130 8051.
- For thickness: 2 - 20 mm.

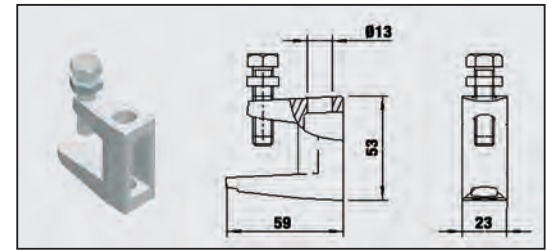

| Art. / Réf. | Farbe  | Coloris | Colour |  | g   |
|-------------|--------|---------|--------|--|-----|
| 4302 0301   | silber | argent  | silver |  | 195 |

### Ringmutter

- Zur Schienenabhängung.
- Mit Befestigungsset zur Direktmontage.

### Anneau de levage

- Pour une suspension du rail.
- Avec kit de fixation pour montage direct sur rail.

### Eye Bolt

- For track suspension.
- With attachment kit for direct track mounting.

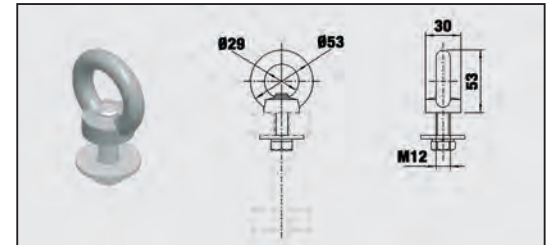

| Art. / Réf. | Farbe  | Coloris | Colour |  | g   |
|-------------|--------|---------|--------|--|-----|
| 4302 9001   | silber | argent  | silver |  | 155 |

Befestigungsmittel und Zubehör / Moyens de fixation et accessoires / Accessories and Hardware

Seile / Drisses / Rope

| <b>Polyesterseil</b> |               | <b>Drisse polyester</b> |                | <b>Polyester Rope</b> |                   |
|----------------------|---------------|-------------------------|----------------|-----------------------|-------------------|
| Material:            | Polyester     | Composition :           | polyester      | Material:             | Polyester         |
| Bruchlast            |               | Charge                  |                | Tensile Strength      |                   |
| (Ø 6 mm):            | ca. 590 daN   | (Ø 6 mm):               | env. 590 daN   | (Ø 6 mm):             | approx. 590 daN   |
| (Ø 8 mm):            | ca. 1.100 daN | (Ø 8 mm):               | env. 1.100 daN | (Ø 8 mm):             | approx. 1.100 daN |

| Art. / Réf. | Farben  | Coloris | Colours | Ø | mm |  | m   |
|-------------|---------|---------|---------|---|----|---|-----|
| 4104 1161   | weiß    | blanc   | white   | 6 |    |   | 200 |
| 4104 1162   | schwarz | noir    | black   | 6 |    |   | 200 |
| 4104 1181   | weiß    | blanc   | white   | 8 |    |   | 200 |
| 4104 1182   | schwarz | noir    | black   | 8 |    |   | 200 |

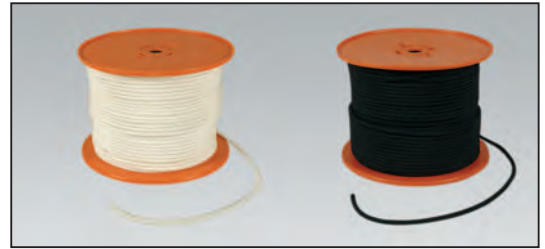

| <b>Kevlarseil</b> |               | <b>Drisse kevlar étiré</b> |                | <b>Kevlar rope</b> |                   |
|-------------------|---------------|----------------------------|----------------|--------------------|-------------------|
| Bruchlast         |               | Charge                     |                | Tensile Strength   |                   |
| (Ø 8 mm):         | ca. 1.200 daN | (Ø 8 mm):                  | env. 1.200 daN | (Ø 8 mm):          | approx. 1.200 daN |

| Art. / Réf. | Farben  | Coloris | Colours | Ø | mm |  | m   |
|-------------|---------|---------|---------|---|----|---|-----|
| 4305 0401   | schwarz | noir    | black   | 8 |    |   | 200 |

| <b>Stahlseil, DIN 3060</b> |               | <b>Câble acier, DIN 3060</b> |                | <b>Steel rope, DIN 3060</b> |                   |
|----------------------------|---------------|------------------------------|----------------|-----------------------------|-------------------|
| Bruchlast                  |               | Charge                       |                | Tensile Strength            |                   |
| (Ø 3 mm):                  | ca. 490 daN   | (Ø 3 mm):                    | env. 490 daN   | (Ø 3 mm):                   | approx. 490 daN   |
| (Ø 4 mm):                  | ca. 870 daN   | (Ø 4 mm):                    | env. 870 daN   | (Ø 4 mm):                   | approx. 870 daN   |
| (Ø 5 mm):                  | ca. 1.360 daN | (Ø 5 mm):                    | env. 1.360 daN | (Ø 5 mm):                   | approx. 1.360 daN |
| (Ø 6 mm):                  | ca. 1.960 daN | (Ø 6 mm):                    | env. 1.960 daN | (Ø 6 mm):                   | approx. 1.960 daN |
| (Ø 7 mm):                  | ca. 2.670 daN | (Ø 7 mm):                    | env. 2.670 daN | (Ø 7 mm):                   | approx. 2.670 daN |

| Art. / Réf. | Farben | Coloris | Colours | Ø | mm |  | m |
|-------------|--------|---------|---------|---|----|---|---|
| 4305 0101   | silber | argent  | silver  | 3 |    |   | - |
| 4305 0102   | silber | argent  | silver  | 4 |    |   | - |
| 4305 0103   | silber | argent  | silver  | 5 |    |   | - |
| 4305 0104   | silber | argent  | silver  | 6 |    |   | - |
| 4305 0105   | silber | argent  | silver  | 7 |    |   | - |

| <b>Stahlseil, DIN 3055, PVC ummantelt</b> |             | <b>Câble acier gainé PVC, DIN 3055</b> |              | <b>Steel rope, DIN 3055, PVC coated</b> |                 |
|---|-------------|--|--------------|---|-----------------|
| Bruchlast                                 |             | Charge                                 |              | Tensile Strength                        |                 |
| (Ø 4 mm):                                 | ca. 490 daN | (Ø 4 mm):                              | env. 490 daN | (Ø 4 mm):                               | approx. 490 daN |

| Art. / Réf. | Farben | Coloris | Colours | Ø | mm |  | m |
|-------------|--------|---------|---------|---|----|---|---|
| 4305 0106   | -      | -       | -       | 4 |    |   | - |

## Befestigungsmittel und Zubehör / Moyens de fixation et accessoires / Accessories and Hardware

### Kederschlauch

- PE-Schlauch für Kederprofile.

### Cordon de tension pour profilé aluminium

- Cordon en polyéthylène.

### Keder pipe

- PE pipe for aluminium profiles.

| Art. / Réf.      | Farbe       | Coloris     | Colour | Ø | mm |
|------------------|-------------|-------------|--------|---|----|
| <b>4305 0616</b> | transparent | transparent | clear  |   | 6  |
| <b>4305 0618</b> | transparent | transparent | clear  |   | 8  |



### Bodenspannleiste, gerade

- Zum Spannen und Fixieren von Folien und Tüchern mittels Klettband.
- Werden mit befestigtem Klettband geliefert.
- Winkelstahl mit Holzbeplankung.
- Länge max.: 6 m.

### Profilé de tension sol, droit

- Pour fixer et tendre des toiles ou cyclos PVC par velcro.
- Livré avec du velcro.
- Profilé acier en L avec placage bois.
- Longueur max. : 6 m.

### Mounting Flange Bracket, Straight

- For tensioning and fixing screens and cloth with velcro tape.
- Velcro attached.
- Angle steel with wood.
- Length max.: 6 m.

| Art. / Réf.      | Farbe   | Coloris | Colour | g/m |
|------------------|---------|---------|--------|-----|
| <b>4306 0100</b> | schwarz | noir    | black  | 600 |

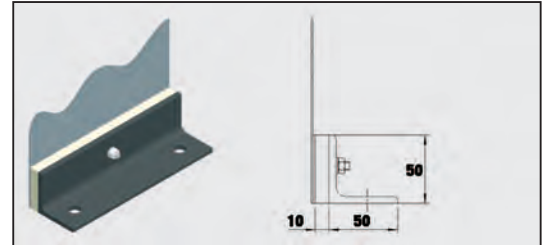

### Bodenspannleiste, gebogen

- Zum Spannen und Fixieren von Folien und Tüchern mittels Klettband.
- Werden mit befestigtem Klettband geliefert.
- Winkelstahl mit Holzbeplankung.
- Radius min.: 2 m.
- Abwicklungslänge max.: 5,40 m.

### Profilé de tension sol, cintré

- Pour fixer et tendre des toiles ou cyclos PVC par velcro.
- Livré avec du velcro.
- Profilé acier en L avec placage bois.
- Rayon mini. de cintrage : 2 m.
- Développé max. : 5,40 m.

### Mounting Flange Bracket, Curved

- For tensioning and fixing screens and cloth with velcro tape.
- Velcro attached.
- Angle steel with wood.
- Radius minimum: 2 m.
- Length max.: 5,40 m.

| Art. / Réf.      | Farbe   | Coloris | Colour | g/m |
|------------------|---------|---------|--------|-----|
| <b>4306 0200</b> | schwarz | noir    | black  | 600 |

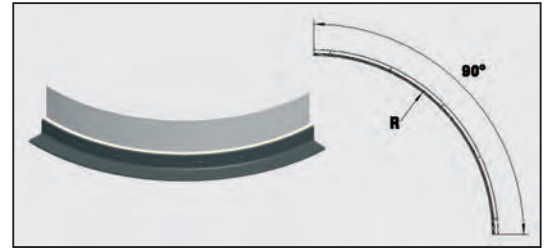

### Beschwerungsrohr, schraubbar

- Material: Stahl, Ø 28 mm.
- Konische Trapezschraubverbindung.

### Tube de lestage

- Raccord par vissage.
- Matériau : acier, Ø 28 mm.

### Bottom Weight Pipe, Threaded Connection

- Material: steel, Ø 28 mm.

| Art. / Réf.      | Farbe             | Coloris    | Colour           | m  | g      |
|------------------|-------------------|------------|------------------|--|--------|
| <b>4307 0101</b> | schwarz, lackiert | laqué noir | black, varnished | Länge /                                      | 1 1500 |
| <b>4307 0102</b> | schwarz, lackiert | laqué noir | black, varnished | Longueur /                                   | 2 2800 |
| <b>4307 0103</b> | schwarz, lackiert | laqué noir | black, varnished | Length                                       | 3 4100 |
| <b>4307 0104</b> | schwarz, lackiert | laqué noir | black, varnished |  | 4 5400 |
| <b>4307 0105</b> | schwarz, lackiert | laqué noir | black, varnished |  | 5 6700 |
| <b>4307 0106</b> | schwarz, lackiert | laqué noir | black, varnished |  | 6 8000 |
| <b>4307 0109</b> | schwarz, lackiert | laqué noir | black, varnished | Sonderlänge / Longueur spéciale / Cut length | -      |

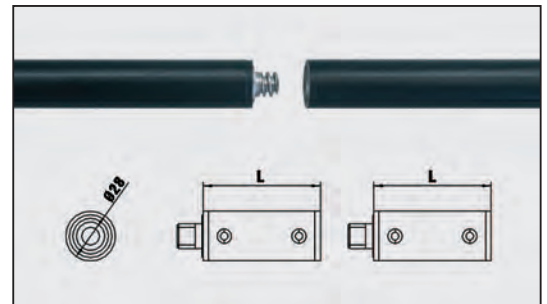

### Satz Endkappen

- Abschlusskappen aus Kunststoff.
- Für Beschwerungsrohr Ø 28 mm.

### Lot de 2 embouts

- Embouts en plastique.
- Pour tube de lestage Ø 28 mm.

### Plastic End Caps

- For Bottom Weight Pipe Ø 28 mm.

| Art. / Réf.      | Farbe   | Coloris | Colour | g  |
|------------------|---------|---------|--------|----|
| <b>4307 0191</b> | schwarz | noir    | black  | 30 |

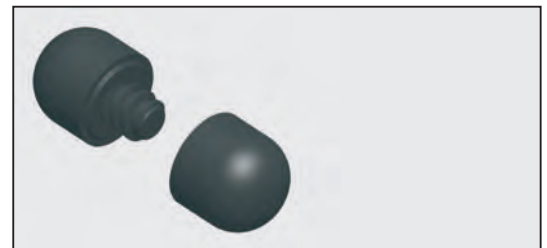

Befestigungsmittel und Zubehör / Moyens de fixation et accessoires / Accessories and Hardware

9

**Beschwerungsrohr, schraubbar**

- Material: Stahl, Ø 50 mm.
- Konische Trapezsraubverbindung.

**Tube de lestage**

- Raccord par vissage.
- Matériau : acier, Ø 50 mm.

**Bottom Weight Pipe, Threaded Connection**

- Material: steel, Ø 50 mm.

| Art. / Réf.      | Farbe | Coloris    | Colour    |   | m | g    |
|------------------|-------|------------|-----------|---|---|------|
| <b>4307 0201</b> | natur | alu nature | aluminium | Länge /   | 1 | 1800 |
| <b>4307 0202</b> | natur | alu nature | aluminium | Longueur /                                      | 2 | 3000 |
| <b>4307 0203</b> | natur | alu nature | aluminium | Length  | 3 | 4200 |
| <b>4307 0204</b> | natur | alu nature | aluminium |   | 4 | 5400 |
| <b>4307 0205</b> | natur | alu nature | aluminium |   | 5 | 6600 |
| <b>4307 0206</b> | natur | alu nature | aluminium |   | 6 | 7800 |
| <b>4307 0209</b> | natur | alu nature | aluminium | Sonderlänge / Longueur<br>spéciale / Cut length |   | -    |

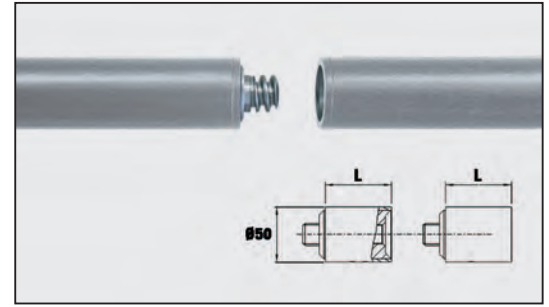

**Satz Endkappen**

- Abschlusskappen aus Kunststoff.
- Für Beschwerungsrohr Ø 50 mm.

**Lot de 2 embouts**

- Embouts en plastique.
- Pour tube de lestage Ø 50 mm.

**Plastic End Caps**

- For Bottom Weight Pipe Ø 50 mm.

| Art. / Réf.      | Farbe   | Coloris | Colour |  | g  |
|------------------|---------|---------|--------|--|----|
| <b>4307 0291</b> | schwarz | noir    | black  |  | 30 |

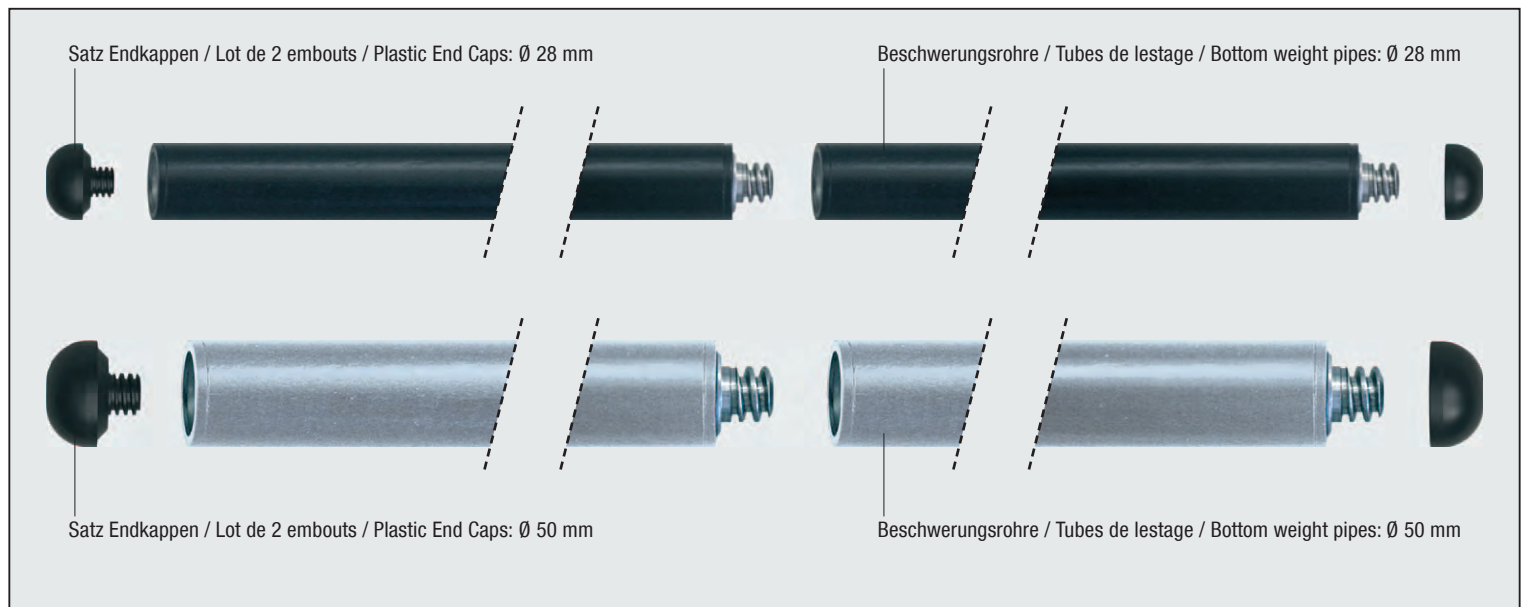

## Befestigungsmittel und Zubehör / Moyens de fixation et accessoires / Accessories and Hardware

### Verbindungsstifte, 10er Set

Goujons de raccord, kit 10 pièces

Joint Pins, 10 Pieces per Set

| Art. / Réf.      | Für Schienensysteme / Pour rails / For Track Systems: | g |
|------------------|---|---|
| <b>3105 9115</b> | ASS   | 1 |
| <b>3100 9115</b> | TRUMPF / TRUMPF 95                                    | 1 |
| <b>3120 9115</b> | STUDIO / E  | 1 |
| <b>3125 9115</b> | JOKER 95  | 1 |



### Verbindungsstift Edelstahl, 10er Set

- Stahlstift Ø 2,5 mm.
- Für einfacheres demontieren der Schienen.
- Einseitig konisch.

### Broche de connexion, inoxydable, kit 10 pièces

- Goujon acier Ø 2,5 mm.
- Pour faciliter le démontage des rails.
- Un côté conique.

### Connection Pin, stainless steel, 10 pieces per set

- Steel pin Ø 2,5 mm.
- For easier disassembling of the tracks.
- Tapered cone.

| Art. / Réf.      | Für Schienensysteme / Pour rails / For Track Systems: | g  |
|------------------|---|----|
| <b>3100 9117</b> | TRUMPF / TRUMPF 95                                    | 10 |

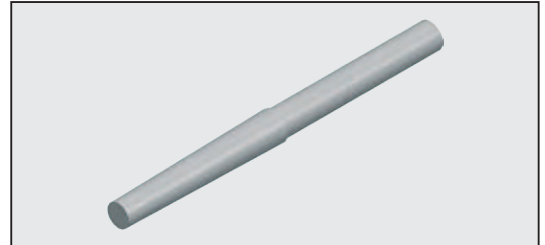

### Verbindungsstift Edelstahl, 10er Set

- Stahlstift Ø 5,2 mm.
- Für einfacheres demontieren der Schienen.
- Einseitig konisch.

### Broche de connexion, inoxydable, kit 10 pièces

- Goujon acier Ø 5,2 mm.
- Pour faciliter le démontage des rails.
- Un côté conique.

### Connection Pin, stainless steel, 10 pieces per set

- Steel pin Ø 5,2 mm.
- For easier disassembling of the tracks.
- Tapered cone.

| Art. / Réf.      | Für Schienensysteme / Pour rails / For Track Systems: | g  |
|------------------|---|----|
| <b>3125 9117</b> | JOKER 95  | 40 |

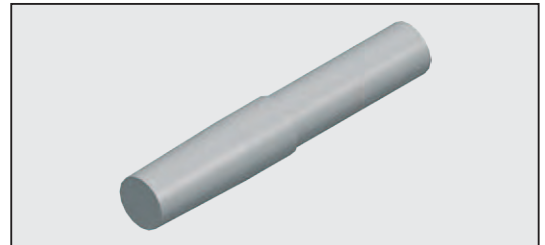

Befestigungsmittel und Zubehör / Moyens de fixation et accessoires / Accessories and Hardware

9

**Bindeband**

Material: Baumwolle  
Nur in ganzen Rollen lieferbar.  
Sonderfarben auf Anfrage.

**Lacette**

Composition : coton  
Uniquement par rouleaux entiers.  
Coloris spéciaux sur demande.

**Tie Line**

Material: Cotton  
Available in full rolls only.  
Custom colours on request.

| Art. / Réf. | Farben      | Coloris | Colours      | B1 M1 EN NFPA | (D) | mm | (D) | m  |
|-------------|-------------|---------|--------------|---------------|-----|----|-----|----|
| 4104 0321   | weiß        | blanc   | white        | •             |     | 20 |     | 50 |
| 4104 0322   | schwarz     | noir    | black        | •             |     | 20 |     | 50 |
| 4104 0323   | rot „Mitte“ | rouge   | red "center" | •             |     | 20 |     | 50 |
| 4104 0324   | blau        | bleu    | blue         | •             |     | 20 |     | 50 |

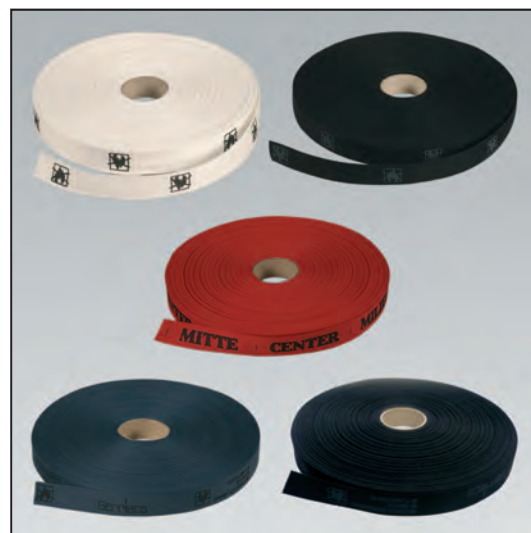

**Bühnenband, 100 % Falten, Dreierfalte**

Material: Polyester  
Faltenabstand: 12 cm  
Nur in ganzen Rollen lieferbar.

**Ruflette, ampleur 100 %, triple pli**

Composition : polyester  
Distance entre plis : 12 cm  
Uniquement par rouleaux entiers.

**Curtain Tape, 100 % fullness, triple pleat**

Material: Polyester  
Pleat spacing: 12 cm  
Available in full rolls only.

| Art. / Réf. | Farben  | Coloris | Colours | B1 M1 EN NFPA | (D) | mm | (D) | m  |
|-------------|---------|---------|---------|---------------|-----|----|-----|----|
| 4104 0151   | weiß    | blanc   | white   |               |     | 50 |     | 50 |
| 4104 0152   | schwarz | noir    | black   |               |     | 50 |     | 50 |

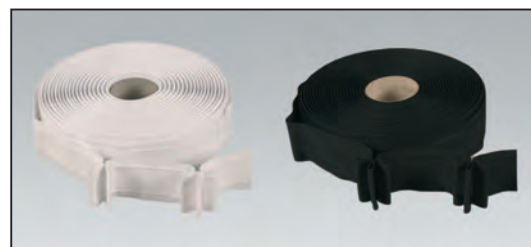

**Drehgasse 1200 mm**

- Drehgasse zur Montage an bauseitiger Unterkonstruktion.
- Aluminiumrohr Ø 50 mm.
- Länge: 1200 mm.

**Support de pendrillons 1200 mm**

- Support de pendrillons orientable préparé pour montage à une sous-construction.
- Tube aluminium Ø 50 mm.
- Longueur : 1200 mm.

**Swivel pipe 1200 mm**

- Rotating pipe for curtain legs, can be mounted under custom sub-structure.
- Aluminium pipe Ø 50 mm.
- Length: 1200 mm.

| Art. / Réf. | Farbe   | Coloris | Colour |  | (D) | g     |
|-------------|---------|---------|--------|--|-----|-------|
| 4308 0220   | schwarz | noir    | black  |  |     | 2.600 |

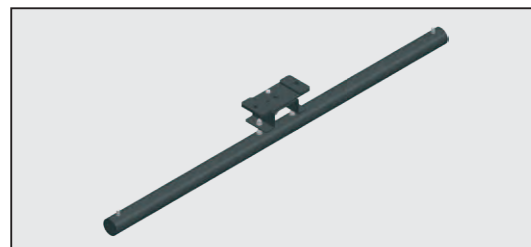

**Drehgasse 1500 mm**

- Drehgasse zur Montage an bauseitiger Unterkonstruktion.
- Aluminiumrohr Ø 50 mm.
- Länge: 1500 mm.

**Support de pendrillons 1500 mm**

- Support de pendrillons orientable préparé pour montage à une sous-construction.
- Tube aluminium Ø 50 mm.
- Longueur : 1500 mm.

**Swivel pipe 1500 mm**

- Rotating pipe for curtain legs, can be mounted under custom sub-structure.
- Aluminium pipe Ø 50 mm.
- Length: 1500 mm.

| Art. / Réf. | Farbe   | Coloris | Colour |  | (D) | g     |
|-------------|---------|---------|--------|--|-----|-------|
| 4308 0250   | schwarz | noir    | black  |  |     | 2.800 |

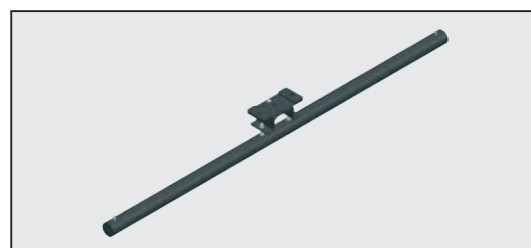

|  |   |   |
|--|---|---|
| <b>Geschäftszeiten / Heures<br/>d'ouverture / Business hours</b>   | Montag - Donnerstag / Lundi - jeudi / Monday - Thursday:  | 08.00 - 12.00 Uhr<br>13.00 - 17.00 Uhr                                      |
|  | Freitag / Vendredi / Friday:  | 08.00 - 12.00 Uhr<br>13.00 - 15.30 Uhr                                      |
|  | Unsere Telefonzentrale ist durchgehend für Sie erreichbar, werktags von 08.00 - 18.00 Uhr, freitags von 08.00 -17.00 Uhr / Notre standard est à votre disposition de 8.00 à 18.00 du lundi au jeudi, et de 8.00 à 17.00 le vendredi / You can reach us at the phone Monday to Thursday from 08:00 a.m. - 06:00 p.m., on Friday from 08:00 a.m. - 05:00 p.m. |   |
|  | Außerhalb der Geschäftszeiten können Sie auf unserem Anrufbeantworter zeitlich unbegrenzt Ihre Nachrichten hinterlassen / En dehors de ces horaires, vous pouvez nous laisser un message sur notre répondeur téléphonique / Outside normal business hours, please leave a message and we will get back to you the next business day.                        |   |
| <b>Anschriften / Adresses / Address</b>  | Lieferanschrift / Adresse de livraison / Shipping address:  | GERRIETS GmbH<br>Bühnenbedarf<br>Im Kirchenhürstle 5 - 7<br>D-79224 Umkirch |
|  | Postanschrift / Adresse postale / Mail address:   | GERRIETS GmbH<br>Bühnenbedarf<br>Postfach 1154<br>D-79220 Umkirch           |
| <b>Telefonnummern / Téléphone /<br/>Phone Numbers</b>  | Zentrale / Standard / Telephone switchboard:  | +49 7665 - 960 0  |
|  | <b>Team 5 Verkauf / Team 5 Vente / Team 5 Sales:</b>  | +49 7665 - 960 250  |
|  | • Theater- und Bühnenausstattung / Équipement scénique des théâtres et opéras /<br>Scenic equipment and curtains for theater and opera  |   |
|  | • Bühnenbildner / Scénographe / Scenic designers  |   |
|  | <b>Team 4 Verkauf / Team 4 Vente / Team 4 Sales:</b>  | +49 7665 - 960 240  |
|  | • Stadthallen / Salles des fêtes / Civic centers  |   |
|  | • Mehrzweckhallen / Salles polyvalentes / Multi purpose halls   |   |
|  | • Schulen / Écoles / Schools  |   |
| • Universitäten / Universités / Universities   |   |   |
| • Kirchengestaltung / Églises / Churches   |   |   |
| • Raumausstattung / Installation de la pièce / Interior decorators   |   |   |
| • Tanzstudios / Studios de danse / Dance studios   |   |   |
| • Fotostudios / Studio photo / Photography studios   |   |   |
| <b>Team 3 Verkauf / Team 3 Vente / Team 3 Sales:</b>   | +49 7665 - 960 230  |   |
| • Veranstaltungstechnik & Events / Événementiel / Special events and concerts                                  |   |   |
| • Freizeitparks / Parcs d'attractions / Theme park   |   |   |
| • Kino- und TV-Studios / Cinéma et studio TV / Film and TV studios   |   |   |
| • Medien-Werbung / Médias-Publicité / Advertising Agencies   |   |   |
| <b>Team 2 Verkauf / Team 2 Vente / Team 2 Sales:</b>   | +49 7665 - 960 220  |   |
| • Messe- und Messebauausstattung / Équipement des salons /<br>Trade show and exhibition construction companies |   |   |
| • Industriekunden / Industries et aménagement / Corporations   |   |   |
| • Schiffsausstattung / Bateaux de croisière / Cruise lines   |   |   |
| <b>Team 1 Verkauf / Team 1 Vente / Team 1 Sales:</b>   | +49 7665 - 960 210  |   |
| • Bühnenbaufirmen / Construction scénique / Scenic shops   |   |   |
| • Planungsbüros und Architekten / Bureaux d'études et architectes / Planners and architects                    |   |   |
| Versandauskunft / Service expédition / Shipping Department:  | +49 7665 - 960 126  |   |
| Buchhaltung / Comptabilité / Accounting Department:  | +49 7665 - 960 170  |   |
| <b>Telefax / Télécopie / Fax numbers</b>   | Zentrale / Standard / General Inquiry:  | +49 7665 - 960 125  |
| <b>Online</b>  | Internet<br>E-mail  | www.gerriets.com<br>info@gerriets.com                                       |
|  | Handelsregister Freiburg / Registre de commerce Freiburg / Commercial register, Freiburg:<br>UST-ID-Nr. / Numéro Identification TVA / Tax number:   | HRB-Nr. 2678<br>142191543   |
|  | Geschäftsführer / Gérants / Managing Directors:   | Hannes Gerriets<br>Bernd Baumeister   |

Gerriets GmbH  
Im Kirchenhürstle 5-7  
DE-79224 Umkirch  
☎ +49 7665 960 0  
☎ +49 7665 960 125  
info@gerriets.com  
www.gerriets.com

Gerriets S. A. R. L.  
Rue du Pourquoi Pas  
FR-68600 Volgelsheim  
☎ +33 3 89 22 70 22  
☎ +33 3 89 22 70 50  
info@gerriets.fr  
www.gerriets.fr

Gerriets International Inc.  
130 Winterwood Avenue  
US-Ewing NJ 08638  
☎ +1 609 771 8111  
☎ +1 609 771 8118  
info@gerriets.us  
www.gerriets.us

Gerriets Great Britain Ltd.  
18 Verney Road  
GB-London SE16 3DH  
☎ +44 20 7639 7704  
☎ +44 20 7732 5760  
info@gerriets.co.uk  
www.gerriets.co.uk

Gerriets Austria CEE GmbH  
Gorskistraße 8  
AT-1230 Wien  
☎ +43 1 6000 600 0  
☎ +43 1 6032 585  
info@gerriets.at  
www.gerriets.at

Gerriets España S. L.  
Pol. Ind. Camporosso Sur  
Avda. de Las Moreras  
Sector 1, Naves 1-2-3  
ES-28350 Ciempozuelos, Madrid  
☎ +34 91 134 5022  
☎ +34 91 134 5084  
info@gerriets.es  
www.gerriets.es

Gerriets Belgique  
Distribué par :  
Gerriets S. A. R. L.  
Rue du Pourquoi Pas  
FR-68600 Volgelsheim  
☎ +33 3 89 22 70 22  
☎ +33 3 89 22 70 50  
info@gerriets.fr  
www.gerriets.fr

Gerriets Nederland  
LevTec BV  
Pieter Braaijweg 51  
NL-1114 AJ Amsterdam-Duivendrecht  
☎ +31 20 40 82 553  
☎ +31 20 40 82 662  
info@gerriets.nl  
www.gerriets.nl

Gerriets Italia  
Risam for show  
Viale Spagna 150 / B  
IT-20093 Cologno Monzese (MI)  
☎ +39 02 2532 113  
☎ +39 02 2532 130  
info@gerriets.it  
www.gerriets.it

Gerriets Hellas  
Stage Art EPE  
Stournari 27B  
GR-10682 Athens  
☎ +30 210 3836 715  
☎ +30 210 3811 929  
info@gerriets.gr  
www.gerriets.gr

Gerriets Turkey  
Benart Sound-Light-Vision-Stage System  
Ibrahim Karaoglanoglu Cad.  
Altinok Plaza No:37 K:3  
Seyrantepe – Kağıthane  
TR-34418 Istanbul  
☎ +90 212 254 33 43  
☎ +90 212 254 33 53  
benart@benart.net  
www.benart.net

Gerriets Slovenija  
(Croatia, Bosnia and Herzegovina,  
Serbia, Montenegro, Macedonia,  
Kosovo)  
MAORI, d.o.o.  
Špruha 14  
SI-1236 loc Trzin  
☎ +386 143 052 79  
☎ +386 590 27 508  
info@gerriets.si  
www.gerriets.si

Gerriets Hungária  
Gépbér Hungária Ltd  
Mester u. 87  
HU-1095 Budapest  
☎ +36 147 665 21  
☎ +36 147 665 20  
info@gerriets.hu  
www.gerriets.hu

Gerriets Romania  
Distributed by:  
Gerriets Austria CEE GmbH  
Gorskistraße 8  
AT-1230 Wien  
☎ +43 1 6000 600 0  
☎ +43 1 6032 585  
info@gerriets.at  
www.gerriets.at

Gerriets Bulgaria  
Landau Impex GmbH  
Shavarski pat Str. No. 3  
BG-1000 Sofia, Losenetz  
☎ +35 92 862 92 44  
☎ +35 92 868 71 16  
info@gerriets.bg  
www.gerriets.bg

Gerriets Korea Co., Ltd.  
22-12, Ogab-gil 192beon-gil,  
Gamgok-myeon,Eumseong-gun,  
Chungcheongbuk-do  
Korea 369-852  
☎ +82 2 477 7713  
☎ +82 2 477 1490  
info@gerriets.co.kr  
www.gerriets.co.kr

Gerriets South Africa  
AVL Distribution  
P.O.Box 70740  
4, Ealing Crescent  
ZA-2021 Bryanston  
☎ +27 11 463 5804  
☎ +27 11 463 5809  
info@gerriets.co.za  
www.gerriets.co.za

Gerriets Brasil  
Stefan Herbert Bottcher Comercio  
Rua dos Inconfidentes 867 2º andar  
Bairro Savassi  
cep. 30140-120 Belo Horizonte MG  
Brasil  
☎ +55 31 2537 5468  
☎ +55 31 99201 4700  
stefanbottcher@gerrietsbrasil.com.br  
www.gerrietsbrasil.com.br

Gerriets Czech Republic / Slovakia  
firmy GERRIETS pro CR a SR  
Boretická 4  
CZ-62800 BRNO  
☎ +420 731 064 022  
info@gerriets.cz  
www.gerriets.cz

