

D Befestigungsmittel
und Zubehör

F Accessoires

E Attachment
Accessories and
Clamps

Unverzichtbar für jede Veranstaltung

- Befestigungsmittel
- Schäkkel
- Karabiner
- Schellen
- Rohrhaken
- Klemmen
- Klammern
- Ringmutter
- Seile
- Bodenspannleisten
- Beschwerungsrohre
- Verbindungsstifte
- Bühnen- und Bindebänder

Moyens de fixation et accessoires

- Attaches
- Manilles
- Mousquetons
- Colliers
- Crochets de suspension
- Pinces
- Anneau de levage
- Drisses
- Profilés de tension sol
- Tubes de lestage
- Goujons de raccord
- Sangles et lacettes

Useful Accessories

- Spannfix bungee hooks.
- Shackles.
- Carabiners.
- Couplers.
- Hook clamps.
- Clamps.
- Brackets.
- Eye bolts.
- Ropes.
- Mounting flange brackets for tensioning fabrics.
- Bottom weight pipes.
- Connection pins.
- Curtain tape and tie lines



Auswahl aus unserem Zubehör

1 Half-Coupler und Swivel-Coupler

- Für Rohre Ø 30 - 51 mm.
- TÜV geprüft.
- Tragkraft 100 - 750 kg.

2 Doughty-HD-Trigger-Clamp

- Für Rohre Ø 38 - 51 mm.
 - TÜV geprüft.
 - Tragkraft: 100 kg.
- Rohrhaken
- Für Rohre Ø 48 - 60 mm.
 - Tragkraft: 100 kg.

3 Bodenspannleisten

- Zum Spannen und Fixieren von Folien und Tüchern mittels Klettband.
- Winkelstahl mit Holzbeplankung.
- Bodenspannleiste, gerade Länge: max. 6 m.
- Bodenspannleiste, gebogen Radius: min. 2 m. Abwicklungslänge max. 5,40 m.

4 Beschwerungsrohre, schraubbar

- Längen: 1 - 6 m, Sonderlängen auf Anfrage.
- Konische Trapezschraubverbindung.
- Abschlusskappen aus Kunststoff.
- In Stahl: Farbe schwarz, lackiert, Ø 28 x 2 mm.
- In Aluminium: Farbe natur, Ø 50 x 3 mm.

5 Satz Endkappen

- Abschlusskappen aus Kunststoff.
- Für Beschwerungsrohr Ø 28 mm und Ø 50 mm.
- Farbe: schwarz.

Choix d'accessoires

1 Colliers simple et double

- Pour tube Ø 30 - 51 mm.
- Certifié TÜV.
- Charge 100 - 750 kg.

2 Collier simple HD DOUGHTY

- Pour tube Ø 38 - 51 mm.
 - Certifié TÜV.
 - Charge : 100 kg.
- Crochet de suspension
- Pour tube Ø 48 - 60 mm.
 - Charge : 100 kg.

3 Profilés de tension sol

- Pour fixer et tendre des toiles ou cyclos PVC par velcro.
- Profilé acier en L avec placage bois.
- Profilé de tension sol, droit, longueur : max. 6 m.
- Profilé de tension sol, cintré, rayon mini. de cintrage : 2 m. Développé max. : 5,40 m.

4 Tubes de lestage

- Longueurs : 1 - 6 m, longueurs spéciales sur demande.
- Raccord par vissage.
- Avec embouts plastique.
- En acier : coloris laqué noir, Ø 28 x 2 mm.
- En aluminium : coloris nature, Ø 50 x 3 mm.

5 Lot de 2 embouts

- Embouts en plastique.
- Pour tube de lestage Ø 28 mm et Ø 50 mm.
- Coloris : noir.

Assorted Samples of our Accessories

1 Half-coupler and swivel-coupler

- For tubes Ø 1.18" - 2.00"
- TÜV certified.
- Load capacity 220 - 1,653 lbs.

2 Doughty-HD trigger clamp

- For tubes Ø 1.49" - 2.00"
 - TÜV certified.
 - Load capacity: 220 lbs.
- Hook clamps
- For tubes Ø 1.88" - 2.36"
 - Load capacity: 220 lbs.

3 Mounting flange brackets for tensioning fabrics

- For tensioning and fixing screens and cloth with Velcro® tape.
- Angle steel with wood.
- Mounting flange bracket, straight. Length: max. 19'8".
- Mounting flange bracket, curved. Radius: max. 6'7". Length: max. 17'7".

4 Bottom weight pipes, threaded connection

- Lengths: 3'3" - 19'8". Special lengths on request.
- Threaded connection.
- Plastic end caps.
- Available in steel: Black, varnished, 1.05" x 0.07".
- Available in Aluminum: Natural colour, 1.96" x 0.11".

5 Plastic End Caps

- For Bottom Weight Pipe Ø 28 mm and Ø 50 mm.
- Colour: black.

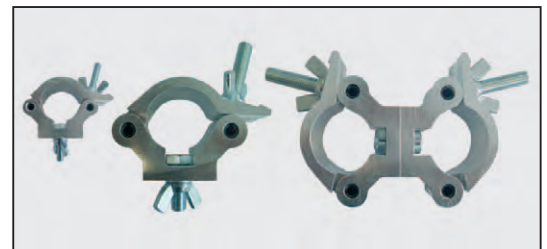

1



2



3

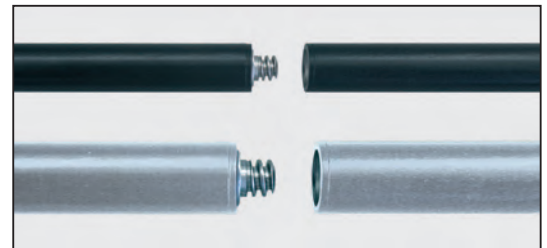

4

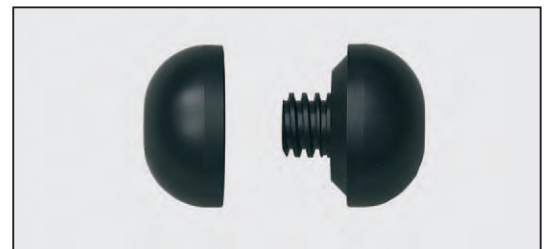

5

Fehler, Technische Änderungen und Irrtümer vorbehalten.
 Sous réserve d'erreurs et de modifications techniques.
 All information subject to change or technical modification without notice.

Befestigungsmittel und Zubehör / Moyens de fixation et accessoires / Accessories and Hardware

Spannfix		Sandow		Spannfix Bungee Cord		
Verpackungseinheit:	100 Stück	Conditionnement :	100 pièces	Pieces per box:	100	
Art. / Réf.	Farben	Coloris	Colours	B1 M1 EN NFPA	g	cm
4107 0101	weiß	blanc	white		10	27
4107 0102	schwarz	noir	black		10	27

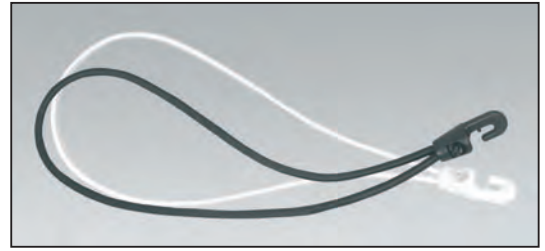

Fastfix		Sandow FASTFIX		Fastfix Bungee Cord		
Verpackungseinheit:	50 Stück	Conditionnement :	50 pièces	Pieces per box:	50	
Art. / Réf.	Farben	Coloris	Colours	B1 M1 EN NFPA	g	cm
4107 0212	schwarz	noir	black		15	40



Easyfix		Pince EASYFIX		Easyfix		
Material:	Nylon, glasfaserverstärkt	Composition :	nylon, renforcé fibre de verre	Material:	Nylon, glass fiber reinforced	
Verpackungseinheit:	250 Stück	Conditionnement :	250 pièces	Pieces per box:	250	
Art. / Réf.	Farben	Coloris	Colours	B1 M1 EN NFPA	g	cm
4107 0301	weiß	blanc	white		20	8
4107 0302	schwarz	noir	black		20	8



Klemmfix		Crochet rapide		Tube Clip		
Material:	Polypropylen	Composition :	polypropylène	Material:	Polypropylene	
Tragkraft:	40 kg	Charge :	40 kg	Load Capacity:	40 kg	
Art. / Réf.	Farben	Coloris	Colours	B1 M1 EN NFPA	g	cm
4107 0402	schwarz	noir	black		45	



Klemmschloss-Zurrgurt		Sangle d'arrimage		Camlock Strap		
Material:	Polyester	Composition :	polyester	Material:	Polyester	
Ideal zur Höhenjustierung von Hauptvorhängen.		Se prête bien pour l'ajustement d'un rideau en hauteur.		For height adjustment of main curtains.		
Art. / Réf.	Farben	Coloris	Colours	B1 M1 EN NFPA	cm	cm
4107 0602	schwarz	noir	black		1,8	80



Befestigungsmittel und Zubehör / Moyens de fixation et accessoires / Accessories and Hardware

G-QUICK

Tragkraft: 3 kg
 Verpackungseinheiten:
 4107 1991/-1992 99 St. schwarz
 1 St. rot

Zur Befestigung von geösten
 Vorhängen und Prospekten.
 Wahlweise mit rotem Verschluss zur
 Mittenmarkierung.

G-QUICK

Charge : 3 kg
 Conditionnement :
 4107 1991/-1992 99 pièces noir
 1 pièce rouge

Pour une suspension rapide de
 rideaux et PVCs de projection
 œillettés.
 Disponible également avec fermeture
 rouge pour repérage du milieu.

G-QUICK

Load Capacity: 3 kg
 Pieces per box:
 4107 1991/-1992 99 black
 1 red

For attaching grommeted draperies
 to pipe battens.
 Available with a red ball to denote
 center position of drape.



Für Laststangen / Pour porteuse / For flying bars: Ø 50 - 60 mm

Art. / Réf.	Farben	Coloris	Colours	B1 M1 EN NFPA	g	cm
4107 1001	schwarz	noir	black		39	17
4107 1011	rot	rouge	red		39	17
4107 1991	schwarz / rot	noir / rouge	black / red		39	17



Für Laststangen / Pour porteuse / For flying bars: Ø 70 - 80 mm

Art. / Réf.	Farben	Coloris	Colours	B1 M1 EN NFPA	g	cm
4107 1002	schwarz	noir	black		42	22
4107 1012	rot	rouge	red		42	22
4107 1992	schwarz / rot	noir / rouge	black / red		42	22



G-CABLE

Verpackungseinheiten: 50 Stück

G-CABLE

Conditionnement : 50 pièces

G-CABLE

Pieces per box: 50

Für Laststangen / Pour porteuse / For flying bars: Ø 50 - 60 mm

Art. / Réf.	Farben	Coloris	Colours	B1 M1 EN NFPA	g	cm
4107 1021	schwarz	noir	black		16	17



Für Laststangen / Pour porteuse / For flying bars: Ø 70 - 80 mm

Art. / Réf.	Farben	Coloris	Colours	B1 M1 EN NFPA	g	cm
4107 1022	schwarz	noir	black		24	22

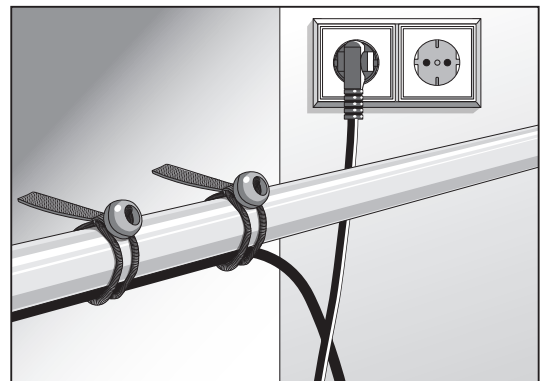

Befestigungsmittel und Zubehör / Moyens de fixation et accessoires / Accessories and Hardware

Schäkel

- Material M4 V2A Stahl.
- Mit Schlitzschrauben-Bolzen.

Manille

- Matériau : acier inox M4 V2A.
- Avec boulon.

Shackle

- Material M4 V2A steel.
- With bolt.

Art. / Réf.	Farbe	Coloris	Colour		mm	g
4302 0501	silber	argent	silver	Maße / Dimensions / Dimensions	25	5
4302 0502	silber	argent	silver		45	17

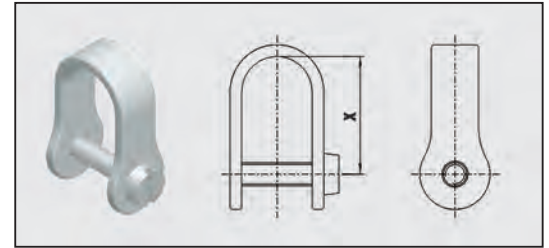

Karabiner

- Feder- und Schraubverschluss.
- Federverschluss.
- Schraubverschluss.

Mousquetons

- Mousqueton.
- Mousqueton.
- Maillon rapide.

Carabiner

- Clip + threaded locking.
- Clip locking.
- Threaded locking.

Art. / Réf.	Farbe	Coloris	Colour		mm	g
4302 0601	silber	argent	silver	Maße / Dimensions / Dimensions	80 / 8	30
4302 0602	silber	argent	silver		60 / 6	28
4302 0603	silber	argent	silver		57 / 5	34



Befestigungsmittel und Zubehör / Moyens de fixation et accessoires / Accessories and Hardware

9

Doughty-Half-Coupler, 75 kg

- Einfachschele.
- Für Rohr Ø 48 - 51 mm.
- Fixings: M10.
- TÜV geprüft.

Collier simple DOUGHTY, 75 kg

- Pour tube Ø 48 - 51 mm.
- Pour boulons M10.
- Certifié TÜV.

Doughty-Half-Coupler, 75 kg

- Single coupler.
- For pipe Ø 48 - 51 mm.
- Fixings: M10.
- TÜV certified.

Art. / Réf.	Farbe	Coloris	Colour	mm	g
4302 0113	alu	alu	aluminum	Breite / Largeur / Width 32	180



Half-Coupler, 100 kg

- Einfachschele.
- Für Rohr Ø 48 - 51 mm.
- Fixings: M10.
- TÜV geprüft.

Collier simple, 100 kg

- Pour tube Ø 48 - 51 mm.
- Pour boulons M10.
- Certifié TÜV.

Half-Coupler, 100 kg

- Single coupler.
- For pipe Ø 48 - 51 mm.
- Fixings: M10.
- TÜV certified.

Art. / Réf.	Farbe	Coloris	Colour	mm	g
4302 0116	alu	alu	aluminum	Breite / Largeur / Width 30	150
4302 0117	schwarz	noir	black	30	150



Half-Coupler ECO, 100 kg

- Einfachschele.
- Für Rohr Ø 48 - 51 mm.
- Fixings: M10.
- Ohne TÜV.

Collier simple ECO, 100 kg

- Pour tube Ø 48 - 51 mm.
- Pour boulons M10.
- Non certifié TÜV.

Half-Coupler ECO, 100 kg

- Single coupler.
- For pipe Ø 48 - 51 mm.
- Fixings: M10.
- Without TÜV.

Art. / Réf.	Farbe	Coloris	Colour	mm	g
4302 0114	alu	alu	aluminum	Breite / Largeur / Width 30	140



Doughty-Half-Coupler, 300 kg

- Einfachschele.
- Für Rohr Ø 48 - 51 mm.
- Fixings: M12.
- TÜV geprüft.

Collier simple DOUGHTY, 300 kg

- Pour tube Ø 48 - 51 mm.
- Pour boulons M12.
- Certifié TÜV.

Doughty-Half-Coupler, 300 kg

- Single coupler.
- For pipe Ø 48 - 51 mm.
- Fixings: M12.
- TÜV certified.

Art. / Réf.	Farbe	Coloris	Colour	mm	g
4302 0111	alu	alu	aluminum	Breite / Largeur / Width 30	320



Half-Coupler ECO, 500 kg

- Einfachschele.
- Für Rohr Ø 48 - 51 mm.
- Fixings: M12.
- Ohne TÜV.

Collier simple ECO, 500 kg

- Pour tube Ø 48 - 51 mm.
- Pour boulons M12.
- Non certifié TÜV.

Half-Coupler ECO, 500 kg

- Single coupler.
- For pipe Ø 48 - 51 mm.
- Fixings: M12.
- Without TÜV.

Art. / Réf.	Farbe	Coloris	Colour	mm	g
4302 0115	alu	alu	aluminum	Breite / Largeur / Width 50	460



Befestigungsmittel und Zubehör / Moyens de fixation et accessoires / Accessories and Hardware

Doughty-Half-Coupler, 500 kg

- Einfachschele.
- Für Rohr Ø 48 - 51 mm.
- Fixings: M12.
- TÜV geprüft.

Collier simple DOUGHTY, 500 kg

- Pour tube Ø 48 - 51 mm.
- Pour boulons M12.
- Certifié TÜV.

Doughty-Half-Coupler, 500 kg

- Single coupler.
- For pipe Ø 48 - 51 mm.
- Fixings: M12.
- TÜV certified.

Art. / Réf.	Farbe	Coloris	Colour	mm	g
4302 0101	alu	alu	aluminum	Breite / Largeur / Width	50 340



Half-Coupler, 500 kg

- Einfachschele.
- Für Rohr Ø 48 - 51 mm.
- Fixings: M12.
- TÜV geprüft.

Collier simple, 500 kg

- Pour tube Ø 48 - 51 mm.
- Pour boulons M12.
- Certifié TÜV.

Half-Coupler, 500 kg

- Single coupler.
- For pipe Ø 48 - 51 mm.
- Fixings: M12.
- TÜV certified.

Art. / Réf.	Farbe	Coloris	Colour	mm	g
4302 0118	alu	alu	aluminum	Breite / Largeur / Width	50 531
4302 0119	schwarz	noir	black	Breite / Largeur / Width	50 531



Doughty-Swivel-Coupler, 500 kg

- Doppelschele.
- 360° drehbar.
- Für Rohr Ø 48 - 51 mm.
- TÜV geprüft.

Collier double DOUGHTY, 500 kg

- Pivotant 360°.
- Pour tube Ø 48 - 51 mm.
- Certifié TÜV.

Doughty-Swivel-Coupler, 500 kg

- Double coupler.
- 360° swivel.
- For pipe Ø 48 - 51 mm.
- TÜV certified.

Art. / Réf.	Farbe	Coloris	Colour	mm	g
4302 0107	alu	alu	aluminum	Breite / Largeur / Width	50 760



Doughty-Half-Coupler, 750 kg

- Einfachschele.
- Für Rohr Ø 48 - 51 mm.
- Fixings: M12.
- TÜV geprüft.

Collier simple DOUGHTY, 750 kg

- Pour tube Ø 48 - 51 mm.
- Pour boulons M12.
- Certifié TÜV.

Doughty-Half-Coupler, 750 kg

- Single coupler.
- For pipe Ø 48 - 51 mm.
- Fixings: M12.
- TÜV certified.

Art. / Réf.	Farbe	Coloris	Colour	mm	g
4302 0102	alu	alu	aluminum	Breite / Largeur / Width	30 410



Doughty-Half-Coupler, 750 kg

- Einfachschele.
- Für Rohr Ø 48 - 51 mm.
- Fixings: M12.
- TÜV geprüft.

Collier simple DOUGHTY, 750 kg

- Pour tube Ø 48 - 51 mm.
- Pour boulons M12.
- Certifié TÜV.

Doughty-Half-Coupler, 750 kg

- Single coupler.
- For pipe Ø 48 - 51 mm.
- Fixings: M12.
- TÜV certified.

Art. / Réf.	Farbe	Coloris	Colour	mm	g
4302 0112	alu	alu	aluminum	Breite / Largeur / Width	50 630



Befestigungsmittel und Zubehör / Moyens de fixation et accessoires / Accessories and Hardware

9

Doughty-Swivel-Coupler, 750 kg

- Doppelschelle.
- 360° drehbar.
- Für Rohr Ø 48 - 51 mm.
- TÜV geprüft.

Collier double DOUGHTY, 750 kg

- Pivotant 360°.
- Pour tube Ø 48 - 51 mm.
- Certifié TÜV.

Doughty-Swivel-Coupler, 750 kg

- Double coupler.
- 360° swivel.
- For pipe Ø 48 - 51 mm.
- TÜV certified.



Art. / Réf.	Farbe	Coloris	Colour	mm	g
4302 0106	alu	alu	aluminum	Breite / Largeur / Width 50	1330

Doughty-Half-Coupler, 500 kg

- Einfachschelle.
- Für Rohr Ø 60 - 63 mm.
- Fixings: M12.
- TÜV geprüft.

Collier simple DOUGHTY, 500 kg

- Pour tube Ø 60 - 63 mm.
- Pour boulons M12.
- Certifié TÜV.

Doughty-Half-Coupler, 500 kg

- Single coupler.
- For pipe Ø 60 - 63 mm.
- Fixings: M12.
- TÜV certified.

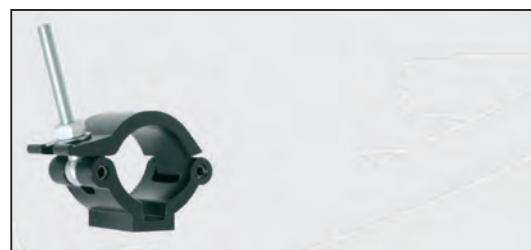

Art. / Réf.	Farbe	Coloris	Colour	mm	g
4302 0110	schwarz	noir	black	Breite / Largeur / Width 50	410

Doughty-Slimline-Trigger-Clamp

- Für Rohr Ø 38 - 51 mm.
- TÜV geprüft.
- Tragkraft: 200 kg.

Collier simple DOUGHTY

- Pour tube Ø 38 - 51 mm.
- Certifié TÜV.
- Charge : 200 kg.

Doughty-Slimline-Trigger-Clamp

- For pipe Ø 38 - 51 mm.
- TÜV certified.
- Load Capacity: 200 kg.



Art. / Réf.	Farbe	Coloris	Colour	mm	g
4302 0109	schwarz	noir	black	Breite / Largeur / Width 30	490

Slimline-Trigger-Clamp

- Für Rohr Ø 48 - 51 mm.
- Fixings: M12.
- TÜV geprüft.
- Tragkraft: 250 kg.

Collier simple HD

- Pour tube Ø 48 - 51 mm.
- Pour boulons M12.
- Certifié TÜV.
- Charge : 250 kg.

Slimline-Trigger-Clamp

- For pipe Ø 48 - 51 mm.
- Fixings: M12.
- TÜV certified.
- Load Capacity: 250 kg.



Art. / Réf.	Farbe	Coloris	Colour	mm	g
4302 0120	alu	alu	aluminum	Breite /	30 471
4302 0121	schwarz	noir	black	Largeur / Width 30	471

Rohrhaken

- Für Rohr Ø 48 - 60 mm.
- Tragkraft: 100 kg.

Crochet de suspension

- Pour tube Ø 48 - 60 mm.
- Charge : 100 kg.

Hook Clamp

- For pipe Ø 48 - 60 mm.
- Load Capacity: 100 kg.



Art. / Réf.	Farbe	Coloris	Colour	mm	g
4302 0201	schwarz	noir	black	Breite / Largeur / Width 42	585

Befestigungsmittel und Zubehör / Moyens de fixation et accessoires / Accessories and Hardware

ERICO-Trägerklemme

- Zur Direktmontage an Stahlbauträgern mit Gewindestange M12 3130 8051.
- Klemmbereich: 2 - 20 mm.

Bride ERICO

- Pour montage direct du rail sur poutres acier en combinaison avec tige filetée M12 3130 8051.
- Réglage : 2 - 20 mm.

ERICO Beam Clamp

- For direct steel beam mounting via M12 threaded bolt 3130 8051.
- For thickness: 2 - 20 mm.

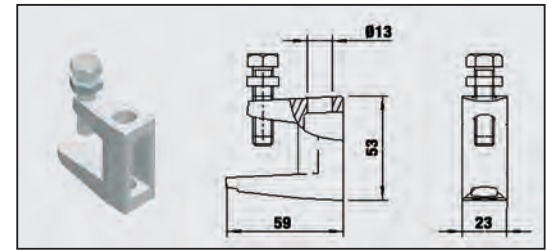

Art. / Réf.	Farbe	Coloris	Colour		g
4302 0301	silber	argent	silver		195

Ringmutter

- Zur Schienenabhängung.
- Mit Befestigungsset zur Direktmontage.

Anneau de levage

- Pour une suspension du rail.
- Avec kit de fixation pour montage direct sur rail.

Eye Bolt

- For track suspension.
- With attachment kit for direct track mounting.

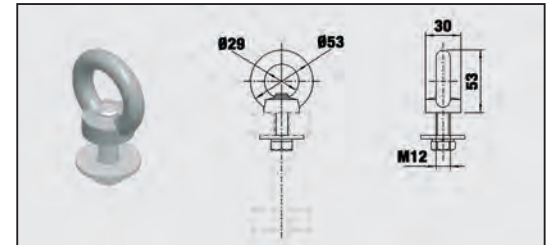

Art. / Réf.	Farbe	Coloris	Colour		g
4302 9001	silber	argent	silver		155

Befestigungsmittel und Zubehör / Moyens de fixation et accessoires / Accessories and Hardware

Seile / Drisses / Rope

Polyesterseil		Drisse polyester		Polyester Rope	
Material:	Polyester	Composition :	polyester	Material:	Polyester
Bruchlast		Charge		Tensile Strength	
(Ø 6 mm):	ca. 590 daN	(Ø 6 mm):	env. 590 daN	(Ø 6 mm):	approx. 590 daN
(Ø 8 mm):	ca. 1.100 daN	(Ø 8 mm):	env. 1.100 daN	(Ø 8 mm):	approx. 1.100 daN

Art. / Réf.	Farben	Coloris	Colours	Ø	mm		m
4104 1161	weiß	blanc	white	6			200
4104 1162	schwarz	noir	black	6			200
4104 1181	weiß	blanc	white	8			200
4104 1182	schwarz	noir	black	8			200

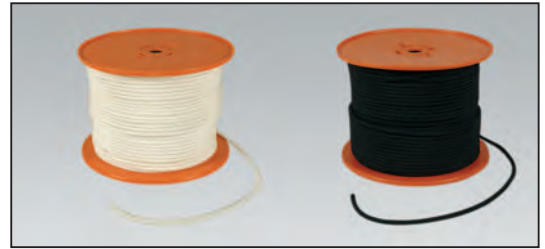

Kevlarseil		Drisse kevlar étiré		Kevlar rope	
Bruchlast		Charge		Tensile Strength	
(Ø 8 mm):	ca. 1.200 daN	(Ø 8 mm):	env. 1.200 daN	(Ø 8 mm):	approx. 1.200 daN

Art. / Réf.	Farben	Coloris	Colours	Ø	mm		m
4305 0401	schwarz	noir	black	8			200

Stahlseil, DIN 3060		Câble acier, DIN 3060		Steel rope, DIN 3060	
Bruchlast		Charge		Tensile Strength	
(Ø 3 mm):	ca. 490 daN	(Ø 3 mm):	env. 490 daN	(Ø 3 mm):	approx. 490 daN
(Ø 4 mm):	ca. 870 daN	(Ø 4 mm):	env. 870 daN	(Ø 4 mm):	approx. 870 daN
(Ø 5 mm):	ca. 1.360 daN	(Ø 5 mm):	env. 1.360 daN	(Ø 5 mm):	approx. 1.360 daN
(Ø 6 mm):	ca. 1.960 daN	(Ø 6 mm):	env. 1.960 daN	(Ø 6 mm):	approx. 1.960 daN
(Ø 7 mm):	ca. 2.670 daN	(Ø 7 mm):	env. 2.670 daN	(Ø 7 mm):	approx. 2.670 daN

Art. / Réf.	Farben	Coloris	Colours	Ø	mm		m
4305 0101	silber	argent	silver	3			-
4305 0102	silber	argent	silver	4			-
4305 0103	silber	argent	silver	5			-
4305 0104	silber	argent	silver	6			-
4305 0105	silber	argent	silver	7			-

Stahlseil, DIN 3055, PVC ummantelt		Câble acier gainé PVC, DIN 3055		Steel rope, DIN 3055, PVC coated	
Bruchlast		Charge		Tensile Strength	
(Ø 4 mm):	ca. 490 daN	(Ø 4 mm):	env. 490 daN	(Ø 4 mm):	approx. 490 daN

Art. / Réf.	Farben	Coloris	Colours	Ø	mm		m
4305 0106	-	-	-	4			-

Befestigungsmittel und Zubehör / Moyens de fixation et accessoires / Accessories and Hardware

Kederschlauch

- PE-Schlauch für Kederprofile.

Cordon de tension pour profilé aluminium

- Cordon en polyéthylène.

Keder pipe

- PE pipe for aluminium profiles.

Art. / Réf.	Farbe	Coloris	Colour	Ø	mm
4305 0616	transparent	transparent	clear		6
4305 0618	transparent	transparent	clear		8



Bodenspannleiste, gerade

- Zum Spannen und Fixieren von Folien und Tüchern mittels Klettband.
- Werden mit befestigtem Klettband geliefert.
- Winkelstahl mit Holzbeplankung.
- Länge max.: 6 m.

Profilé de tension sol, droit

- Pour fixer et tendre des toiles ou cyclos PVC par velcro.
- Livré avec du velcro.
- Profilé acier en L avec placage bois.
- Longueur max. : 6 m.

Mounting Flange Bracket, Straight

- For tensioning and fixing screens and cloth with velcro tape.
- Velcro attached.
- Angle steel with wood.
- Length max.: 6 m.

Art. / Réf.	Farbe	Coloris	Colour	g/m
4306 0100	schwarz	noir	black	600

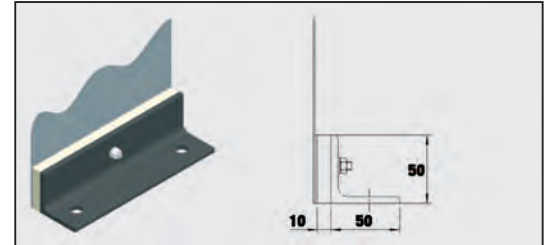

Bodenspannleiste, gebogen

- Zum Spannen und Fixieren von Folien und Tüchern mittels Klettband.
- Werden mit befestigtem Klettband geliefert.
- Winkelstahl mit Holzbeplankung.
- Radius min.: 2 m.
- Abwicklungslänge max.: 5,40 m.

Profilé de tension sol, cintré

- Pour fixer et tendre des toiles ou cyclos PVC par velcro.
- Livré avec du velcro.
- Profilé acier en L avec placage bois.
- Rayon mini. de cintrage : 2 m.
- Développé max. : 5,40 m.

Mounting Flange Bracket, Curved

- For tensioning and fixing screens and cloth with velcro tape.
- Velcro attached.
- Angle steel with wood.
- Radius minimum: 2 m.
- Length max.: 5,40 m.

Art. / Réf.	Farbe	Coloris	Colour	g/m
4306 0200	schwarz	noir	black	600

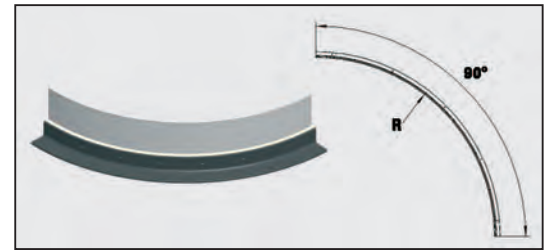

Beschwerungsrohr, schraubbar

- Material: Stahl, Ø 28 mm.
- Konische Trapezschraubverbindung.

Tube de lestage

- Raccord par vissage.
- Matériau : acier, Ø 28 mm.

Bottom Weight Pipe, Threaded Connection

- Material: steel, Ø 28 mm.

Art. / Réf.	Farbe	Coloris	Colour	m	g
4307 0101	schwarz, lackiert	laqué noir	black, varnished	Länge /	1 1500
4307 0102	schwarz, lackiert	laqué noir	black, varnished	Longueur /	2 2800
4307 0103	schwarz, lackiert	laqué noir	black, varnished	Length	3 4100
4307 0104	schwarz, lackiert	laqué noir	black, varnished		4 5400
4307 0105	schwarz, lackiert	laqué noir	black, varnished		5 6700
4307 0106	schwarz, lackiert	laqué noir	black, varnished		6 8000
4307 0109	schwarz, lackiert	laqué noir	black, varnished	Sonderlänge / Longueur spéciale / Cut length	-

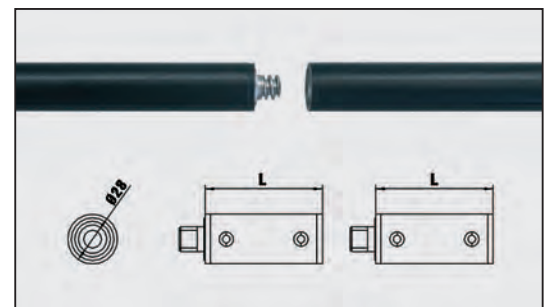

Satz Endkappen

- Abschlusskappen aus Kunststoff.
- Für Beschwerungsrohr Ø 28 mm.

Lot de 2 embouts

- Embouts en plastique.
- Pour tube de lestage Ø 28 mm.

Plastic End Caps

- For Bottom Weight Pipe Ø 28 mm.

Art. / Réf.	Farbe	Coloris	Colour	g
4307 0191	schwarz	noir	black	30

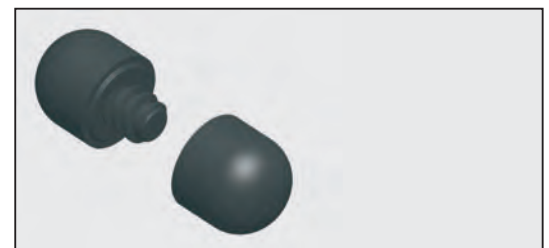

Befestigungsmittel und Zubehör / Moyens de fixation et accessoires / Accessories and Hardware

9

Beschwerungsrohr, schraubbar

- Material: Stahl, Ø 50 mm.
- Konische Trapezsraubverbindung.

Tube de lestage

- Raccord par vissage.
- Matériau : acier, Ø 50 mm.

Bottom Weight Pipe, Threaded Connection

- Material: steel, Ø 50 mm.

Art. / Réf.	Farbe	Coloris	Colour		m	g
4307 0201	natur	alu nature	aluminium	Länge /	1	1800
4307 0202	natur	alu nature	aluminium	Longueur /	2	3000
4307 0203	natur	alu nature	aluminium	Length	3	4200
4307 0204	natur	alu nature	aluminium		4	5400
4307 0205	natur	alu nature	aluminium		5	6600
4307 0206	natur	alu nature	aluminium		6	7800
4307 0209	natur	alu nature	aluminium	Sonderlänge / Longueur spéciale / Cut length		-

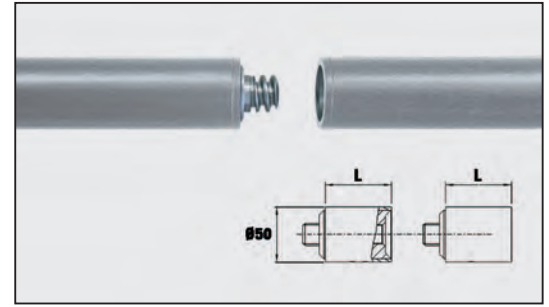

Satz Endkappen

- Abschlusskappen aus Kunststoff.
- Für Beschwerungsrohr Ø 50 mm.

Lot de 2 embouts

- Embouts en plastique.
- Pour tube de lestage Ø 50 mm.

Plastic End Caps

- For Bottom Weight Pipe Ø 50 mm.

Art. / Réf.	Farbe	Coloris	Colour		g
4307 0291	schwarz	noir	black		30

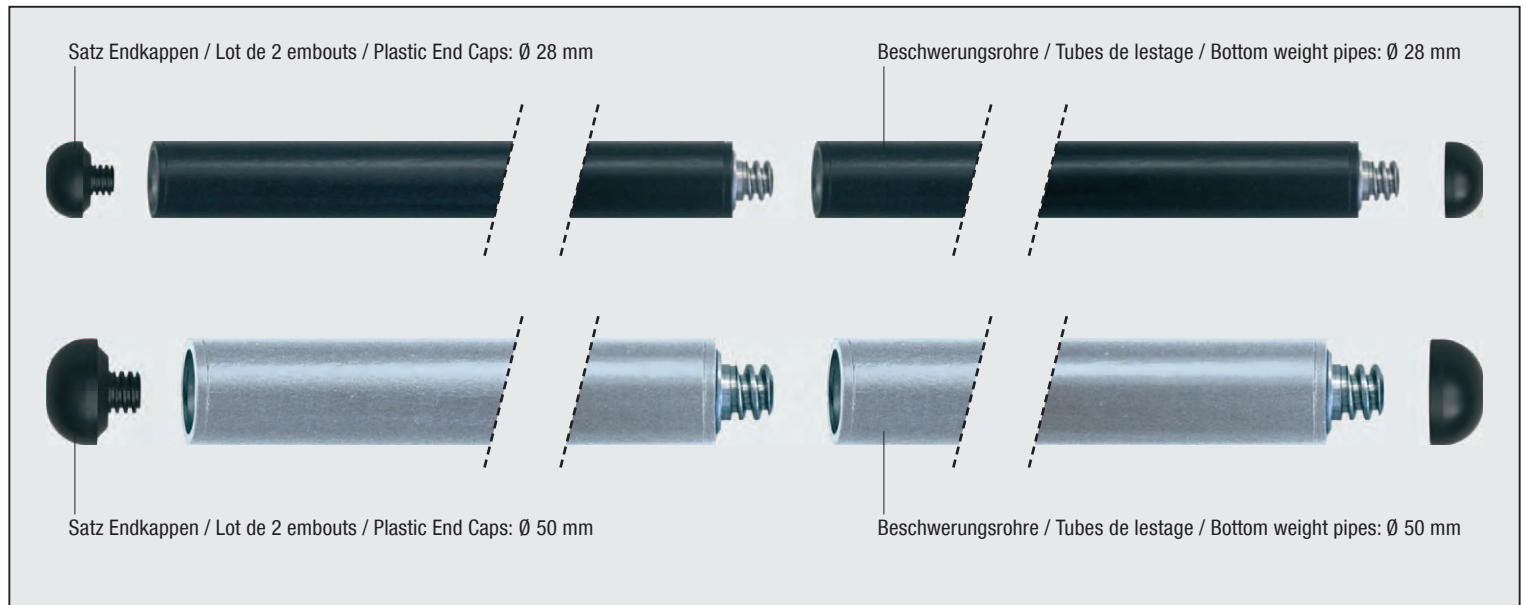

Befestigungsmittel und Zubehör / Moyens de fixation et accessoires / Accessories and Hardware

Verbindungsstifte, 10er Set

Goujons de raccord, kit 10 pièces

Joint Pins, 10 Pieces per Set

Art. / Réf.	Für Schienensysteme / Pour rails / For Track Systems:	g
3105 9115	ASS	1
3100 9115	TRUMPF / TRUMPF 95	1
3120 9115	STUDIO / E	1
3125 9115	JOKER 95	1



Verbindungsstift Edelstahl, 10er Set

- Stahlstift Ø 2,5 mm.
- Für einfacheres demontieren der Schienen.
- Einseitig konisch.

Broche de connexion, inoxydable, kit 10 pièces

- Goujon acier Ø 2,5 mm.
- Pour faciliter le démontage des rails.
- Un côté conique.

Connection Pin, stainless steel, 10 pieces per set

- Steel pin Ø 2,5 mm.
- For easier disassembling of the tracks.
- Tapered cone.

Art. / Réf.	Für Schienensysteme / Pour rails / For Track Systems:	g
3100 9117	TRUMPF / TRUMPF 95	10

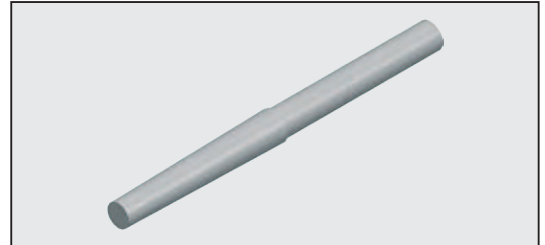

Verbindungsstift Edelstahl, 10er Set

- Stahlstift Ø 5,2 mm.
- Für einfacheres demontieren der Schienen.
- Einseitig konisch.

Broche de connexion, inoxydable, kit 10 pièces

- Goujon acier Ø 5,2 mm.
- Pour faciliter le démontage des rails.
- Un côté conique.

Connection Pin, stainless steel, 10 pieces per set

- Steel pin Ø 5,2 mm.
- For easier disassembling of the tracks.
- Tapered cone.

Art. / Réf.	Für Schienensysteme / Pour rails / For Track Systems:	g
3125 9117	JOKER 95	40

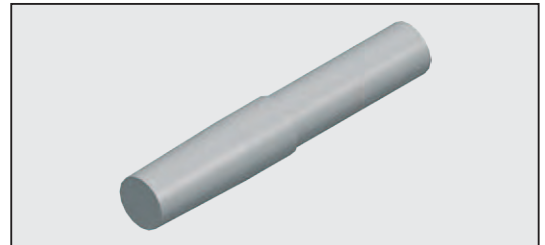

Befestigungsmittel und Zubehör / Moyens de fixation et accessoires / Accessories and Hardware

9

Bindeband

Material: Baumwolle
Nur in ganzen Rollen lieferbar.
Sonderfarben auf Anfrage.

Lacette

Composition : coton
Uniquement par rouleaux entiers.
Coloris spéciaux sur demande.

Tie Line

Material: Cotton
Available in full rolls only.
Custom colours on request.

Art. / Réf.	Farben	Coloris	Colours	B1 M1 EN NFPA	(D)	mm	(D)	m
4104 0321	weiß	blanc	white	•		20		50
4104 0322	schwarz	noir	black	•		20		50
4104 0323	rot „Mitte“	rouge	red "center"	•		20		50
4104 0324	blau	bleu	blue	•		20		50

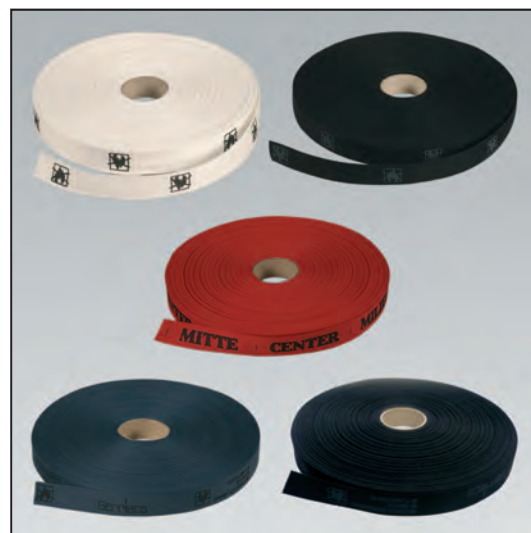

Bühnenband, 100 % Falten, Dreierfalte

Material: Polyester
Faltenabstand: 12 cm
Nur in ganzen Rollen lieferbar.

Ruflette, ampleur 100 %, triple pli

Composition : polyester
Distance entre plis : 12 cm
Uniquement par rouleaux entiers.

Curtain Tape, 100 % fullness, triple pleat

Material: Polyester
Pleat spacing: 12 cm
Available in full rolls only.

Art. / Réf.	Farben	Coloris	Colours	B1 M1 EN NFPA	(D)	mm	(D)	m
4104 0151	weiß	blanc	white			50		50
4104 0152	schwarz	noir	black			50		50

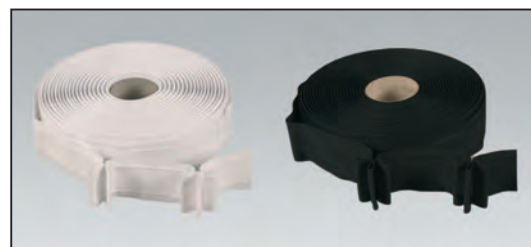

Drehgasse 1200 mm

- Drehgasse zur Montage an bauseitiger Unterkonstruktion.
- Aluminiumrohr Ø 50 mm.
- Länge: 1200 mm.

Support de pendrillons 1200 mm

- Support de pendrillons orientable préparé pour montage à une sous-construction.
- Tube aluminium Ø 50 mm.
- Longueur : 1200 mm.

Swivel pipe 1200 mm

- Rotating pipe for curtain legs, can be mounted under custom sub-structure.
- Aluminium pipe Ø 50 mm.
- Length: 1200 mm.

Art. / Réf.	Farbe	Coloris	Colour		(D)	g
4308 0220	schwarz	noir	black			2.600

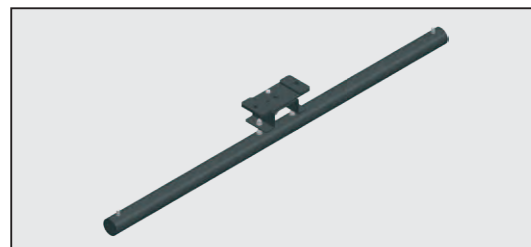

Drehgasse 1500 mm

- Drehgasse zur Montage an bauseitiger Unterkonstruktion.
- Aluminiumrohr Ø 50 mm.
- Länge: 1500 mm.

Support de pendrillons 1500 mm

- Support de pendrillons orientable préparé pour montage à une sous-construction.
- Tube aluminium Ø 50 mm.
- Longueur : 1500 mm.

Swivel pipe 1500 mm

- Rotating pipe for curtain legs, can be mounted under custom sub-structure.
- Aluminium pipe Ø 50 mm.
- Length: 1500 mm.

Art. / Réf.	Farbe	Coloris	Colour		(D)	g
4308 0250	schwarz	noir	black			2.800

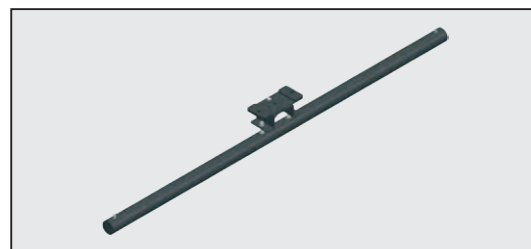

Geschäftszeiten / Heures d'ouverture / Business hours	Montag - Donnerstag / Lundi - jeudi / Monday - Thursday:	08.00 - 12.00 Uhr 13.00 - 17.00 Uhr
	Freitag / Vendredi / Friday:	08.00 - 12.00 Uhr 13.00 - 15.30 Uhr
	Unsere Telefonzentrale ist durchgehend für Sie erreichbar, werktags von 08.00 - 18.00 Uhr, freitags von 08.00 -17.00 Uhr / Notre standard est à votre disposition de 8.00 à 18.00 du lundi au jeudi, et de 8.00 à 17.00 le vendredi / You can reach us at the phone Monday to Thursday from 08:00 a.m. - 06:00 p.m., on Friday from 08:00 a.m. - 05:00 p.m.	
	Außerhalb der Geschäftszeiten können Sie auf unserem Anrufbeantworter zeitlich unbegrenzt Ihre Nachrichten hinterlassen / En dehors de ces horaires, vous pouvez nous laisser un message sur notre répondeur téléphonique / Outside normal business hours, please leave a message and we will get back to you the next business day.	
Anschriften / Adresses / Address	Lieferanschrift / Adresse de livraison / Shipping address:	GERRIETS GmbH Bühnenbedarf Im Kirchenhürstle 5 - 7 D-79224 Umkirch
	Postanschrift / Adresse postale / Mail address:	GERRIETS GmbH Bühnenbedarf Postfach 1154 D-79220 Umkirch
Telefonnummern / Téléphone / Phone Numbers	Zentrale / Standard / Telephone switchboard:	+49 7665 - 960 0
	Team 5 Verkauf / Team 5 Vente / Team 5 Sales:	+49 7665 - 960 250
	• Theater- und Bühnenausstattung / Équipement scénique des théâtres et opéras / Scenic equipment and curtains for theater and opera	
	• Bühnenbildner / Scénographe / Scenic designers	
	Team 4 Verkauf / Team 4 Vente / Team 4 Sales:	+49 7665 - 960 240
	• Stadthallen / Salles des fêtes / Civic centers	
	• Mehrzweckhallen / Salles polyvalentes / Multi purpose halls	
	• Schulen / Écoles / Schools	
• Universitäten / Universités / Universities		
• Kirchengestaltung / Églises / Churches		
• Raumausstattung / Installation de la pièce / Interior decorators		
• Tanzstudios / Studios de danse / Dance studios		
• Fotostudios / Studio photo / Photography studios		
Team 3 Verkauf / Team 3 Vente / Team 3 Sales:	+49 7665 - 960 230	
• Veranstaltungstechnik & Events / Événementiel / Special events and concerts		
• Freizeitparks / Parcs d'attractions / Theme park		
• Kino- und TV-Studios / Cinéma et studio TV / Film and TV studios		
• Medien-Werbung / Médias-Publicité / Advertising Agencies		
Team 2 Verkauf / Team 2 Vente / Team 2 Sales:	+49 7665 - 960 220	
• Messe- und Messebauausstattung / Équipement des salons / Trade show and exhibition construction companies		
• Industriekunden / Industries et aménagement / Corporations		
• Schiffsausstattung / Bateaux de croisière / Cruise lines		
Team 1 Verkauf / Team 1 Vente / Team 1 Sales:	+49 7665 - 960 210	
• Bühnenbaufirmen / Construction scénique / Scenic shops		
• Planungsbüros und Architekten / Bureaux d'études et architectes / Planners and architects		
Versandauskunft / Service expédition / Shipping Department:	+49 7665 - 960 126	
Buchhaltung / Comptabilité / Accounting Department:	+49 7665 - 960 170	
Telefax / Télécopie / Fax numbers	Zentrale / Standard / General Inquiry:	+49 7665 - 960 125
Online	Internet E-mail	www.gerriets.com info@gerriets.com
	Handelsregister Freiburg / Registre de commerce Freiburg / Commercial register, Freiburg: UST-ID-Nr. / Numéro Identification TVA / Tax number:	HRB-Nr. 2678 142191543
	Geschäftsführer / Gérants / Managing Directors:	Hannes Gerriets Bernd Baumeister

Gerriets GmbH
Im Kirchenhürstle 5-7
DE-79224 Umkirch
☎ +49 7665 960 0
☎ +49 7665 960 125
info@gerriets.com
www.gerriets.com

Gerriets S. A. R. L.
Rue du Pourquoi Pas
FR-68600 Volgelsheim
☎ +33 3 89 22 70 22
☎ +33 3 89 22 70 50
info@gerriets.fr
www.gerriets.fr

Gerriets International Inc.
130 Winterwood Avenue
US-Ewing NJ 08638
☎ +1 609 771 8111
☎ +1 609 771 8118
info@gerriets.us
www.gerriets.us

Gerriets Great Britain Ltd.
18 Verney Road
GB-London SE16 3DH
☎ +44 20 7639 7704
☎ +44 20 7732 5760
info@gerriets.co.uk
www.gerriets.co.uk

Gerriets Austria CEE GmbH
Gorskistraße 8
AT-1230 Wien
☎ +43 1 6000 600 0
☎ +43 1 6032 585
info@gerriets.at
www.gerriets.at

Gerriets España S. L.
Pol. Ind. Camporrosso Sur
Avda. de Las Moreras
Sector 1, Naves 1-2-3
ES-28350 Ciempozuelos, Madrid
☎ +34 91 134 5022
☎ +34 91 134 5084
info@gerriets.es
www.gerriets.es

Gerriets Belgique
Distribué par :
Gerriets S. A. R. L.
Rue du Pourquoi Pas
FR-68600 Volgelsheim
☎ +33 3 89 22 70 22
☎ +33 3 89 22 70 50
info@gerriets.fr
www.gerriets.fr

Gerriets Nederland
LevTec BV
Pieter Braaijweg 51
NL-1114 AJ Amsterdam-Duivendrecht
☎ +31 20 40 82 553
☎ +31 20 40 82 662
info@gerriets.nl
www.gerriets.nl

Gerriets Italia
Risam for show
Viale Spagna 150 / B
IT-20093 Cologno Monzese (MI)
☎ +39 02 2532 113
☎ +39 02 2532 130
info@gerriets.it
www.gerriets.it

Gerriets Hellas
Stage Art EPE
Stournari 27B
GR-10682 Athens
☎ +30 210 3836 715
☎ +30 210 3811 929
info@gerriets.gr
www.gerriets.gr

Gerriets Turkey
Benart Sound-Light-Vision-Stage System
Ibrahim Karaoglanoglu Cad.
Altinok Plaza No:37 K:3
Seyrantepe – Kağıthane
TR-34418 Istanbul
☎ +90 212 254 33 43
☎ +90 212 254 33 53
benart@benart.net
www.benart.net

Gerriets Slovenija
(Croatia, Bosnia and Herzegovina,
Serbia, Montenegro, Macedonia,
Kosovo)
MAORI, d.o.o.
Špruha 14
SI-1236 loc Trzin
☎ +386 143 052 79
☎ +386 590 27 508
info@gerriets.si
www.gerriets.si

Gerriets Hungária
Gépbér Hungária Ltd
Mester u. 87
HU-1095 Budapest
☎ +36 147 665 21
☎ +36 147 665 20
info@gerriets.hu
www.gerriets.hu

Gerriets Romania
Distributed by:
Gerriets Austria CEE GmbH
Gorskistraße 8
AT-1230 Wien
☎ +43 1 6000 600 0
☎ +43 1 6032 585
info@gerriets.at
www.gerriets.at

Gerriets Bulgaria
Landau Impex GmbH
Shavarski pat Str. No. 3
BG-1000 Sofia, Losenetz
☎ +35 92 862 92 44
☎ +35 92 868 71 16
info@gerriets.bg
www.gerriets.bg

Gerriets Korea Co., Ltd.
22-12, Ogab-gil 192beon-gil,
Gamgok-myeon, Eumseong-gun,
Chungcheongbuk-do
Korea 369-852
☎ +82 2 477 7713
☎ +82 2 477 1490
info@gerriets.co.kr
www.gerriets.co.kr

Gerriets South Africa
AVL Distribution
P.O.Box 70740
4, Ealing Crescent
ZA-2021 Bryanston
☎ +27 11 463 5804
☎ +27 11 463 5809
info@gerriets.co.za
www.gerriets.co.za

Gerriets Brasil
Stefan Herbert Bottcher Comercio
Rua dos Inconfidentes 867 2º andar
Bairro Savassi
cep. 30140-120 Belo Horizonte MG
Brasil
☎ +55 31 2537 5468
☎ +55 31 99201 4700
stefanbottcher@gerrietsbrasil.com.br
www.gerrietsbrasil.com.br

Gerriets Czech Republic / Slovakia
firmy GERRIETS pro CR a SR
Boretická 4
CZ-62800 BRNO
☎ +420 731 064 022
info@gerriets.cz
www.gerriets.cz

