

SGM[®] LS-3.75
LED PANEL

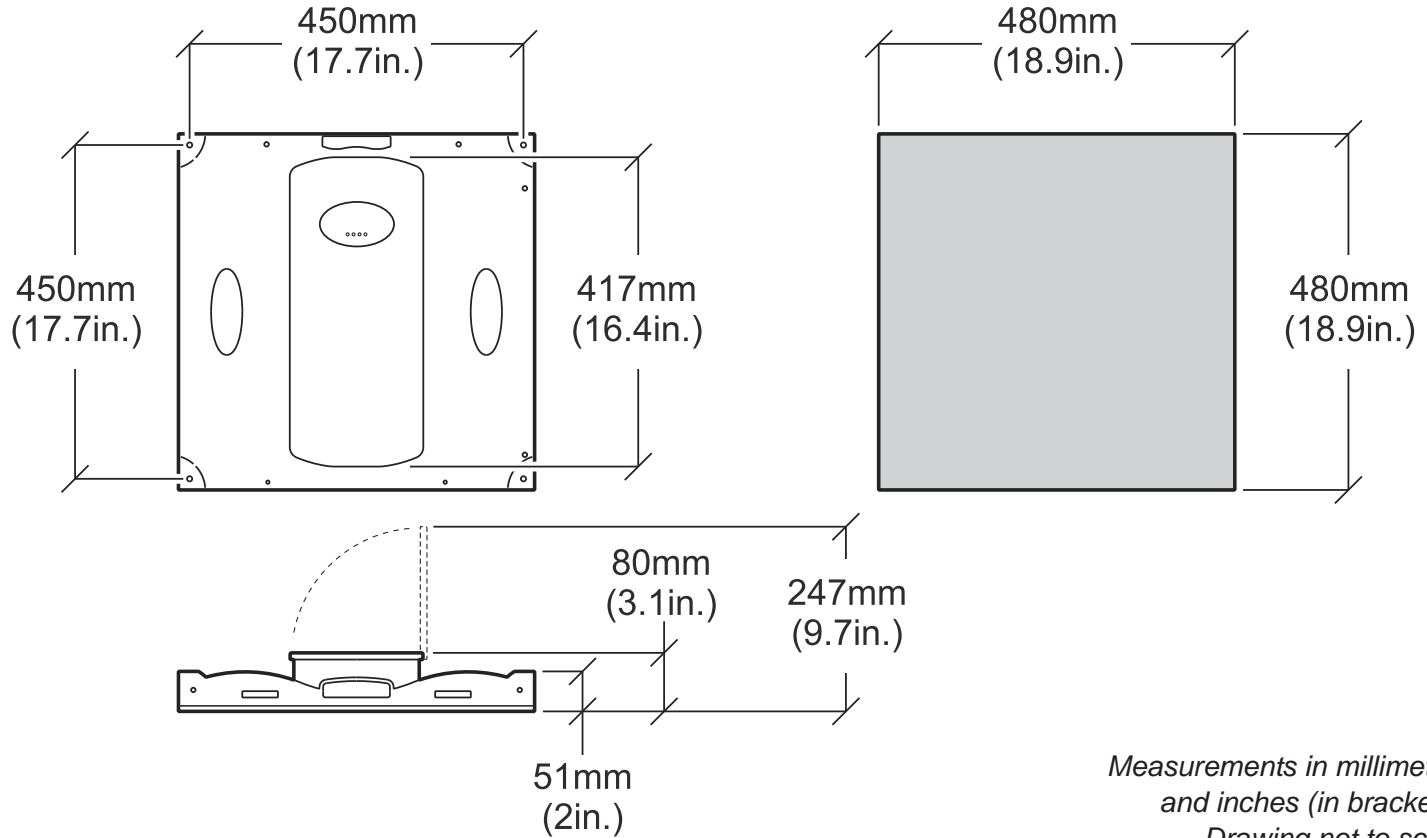

Dimensions



LS-3.75

USER MANUAL

© 2015 SGM™. Information subject to change without notice. SGM and all affiliated companies disclaim liability for any injury, damage, direct or indirect loss, consequential or economic loss or any other loss occasioned by the use of, inability to use or reliance on the information contained in this manual. The SGM logo, the SGM name and all other trademarks in this document pertaining to services or products by SGM or its affiliates and subsidiaries are trademarks owned or licensed by SGM or its affiliates or subsidiaries.

The original edition of this document is in English. All other language editions are translations of the original edition.

This edition applies to firmware version 1 or later.

Rev. 2

Contents

Dimensions	2
Safety information	7
Introduction	9
<i>Parts identification and terminology</i>	10
Connections overview	11
Preparing for installation	12
<i>Transportation</i>	12
<i>Unpacking</i>	12
<i>Before use</i>	13
Installation	14
<i>Physical rigging</i>	16
<i>Signal connection</i>	19
<i>Power connection</i>	20
Dismantling and storage	21
<i>Dismantling</i>	21
<i>Storage</i>	22

Service and maintenance	23
<i>Cleaning</i>	23
Troubleshooting.....	24
Specifications	25
<i>Physical</i>	25
<i>Output</i>	25
<i>Optics</i>	26
<i>Features</i>	26
<i>Electrical</i>	26
<i>Programming and Control</i>	26
<i>Connectors</i>	26
<i>Certifications</i>	27
<i>Included items</i>	27

Ordering information	28
<i>Fixtures</i>	28
<i>Power cables</i>	28
<i>Data cables</i>	28
<i>Controllers</i>	28
<i>Extender kit for controllers</i>	29
<i>Scaler</i>	29
<i>Light sensor</i>	29
<i>Calibration system</i>	29
<i>Rigging</i>	29
<i>Flightcase</i>	30
User's notes	31

Safety information



WARNING! Read the safety precautions in this section before unpacking, installing, powering or operating this product.

The LS-3.75 is intended for indoor, professional use only. It is not suitable for outdoor use or household use.

- Ensure that the power supply units are electrically connected to earth (ground).
- Do not immerse the device in water or liquid.
- Install only in accordance with applicable building codes.

Introduction

The LS-3.75 is an ultra hi-res video panel capable of displaying detailed video from a high-resolution digital video source. The panel is made up of LED modules with 3-in-1 SMD LEDs, making it suitable for applications where both picture quality and brightness are important. The panel offers high light output of 950 cd/m², and a contrast ratio of 1 600:1.

With 3.75 mm pixel pitch, the panel gives the best picture resolution and quality at a viewing distance of 4 meters or more. With a high refresh rate of 2 880 Hz, it is perfect for applications such as television, theatre, exhibitions, show production and concerts. The screen has no fans, making it completely noiseless.

The long-life LED system and very low pixel failure rate makes the LS-3.75 very suitable for permanent installations. At the same time, the 8.5 kg low weight easy-to-assemble panels also provide a very attractive system for touring and rental use. The modular panels can be quickly combined to create large suspended viewing screens. The panel is IP43-rated and is designed for indoor installation.

This manual covers installation, use and maintenance of the LED Panel. For information about installation and use of the LED Controller, see the documentation supplied with the controller. All documentation is also available from the SGM website: <http://www.sgmlight.com>.

Parts identification and terminology

- A Handles
- B Locking latch
- C LED read outs
- D Power out
- E Data link in/out
- F Hatch lock
- G Data link in/out
- H Power in

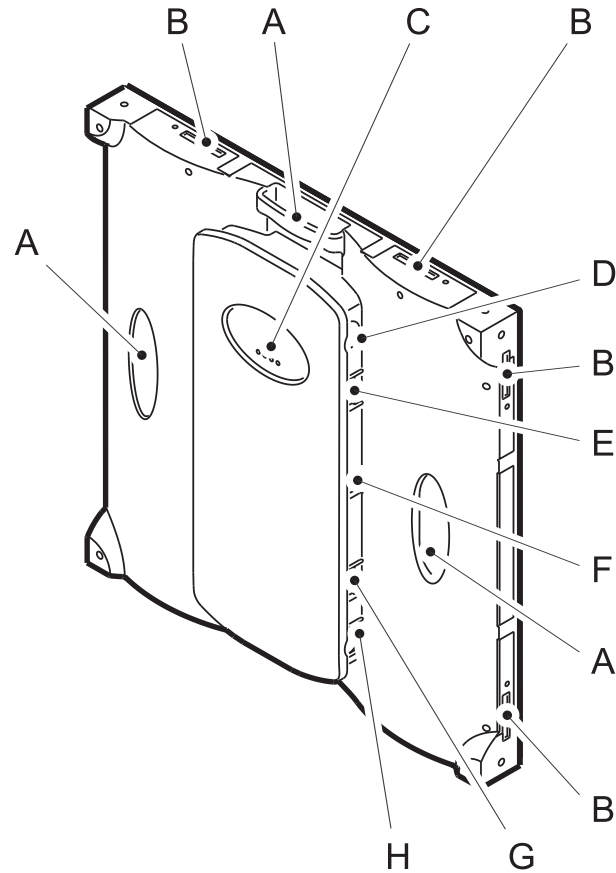

Connections overview

Power		
Pin number	Pin Name	Function
1	L	AC power line
2	N	AC power supply zero line
3	FG	AC power line

Signal	
Pin number	Colour
1	White / Orange
2	Orange
3	White / Green
4	Blue
5	White / Blue
6	Green
7	White / Brown
8	Brown

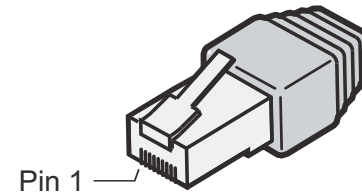
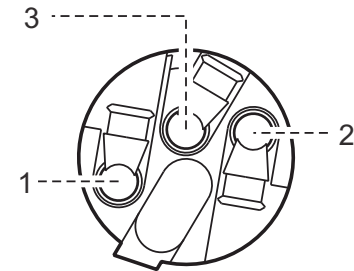
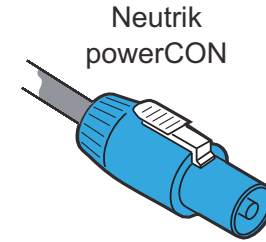

Preparing for installation

Transportation

To protect the panels from shocks that normally occur during transport, they should be packed in an SGM flight case. The product warranty does not cover damage from due to incorrect packing.

Unpacking



CAUTION *Risk of damage to equipment.*

- The LEDs on the panel are fragile. Avoid exposing front and edges of the panels to shocks.

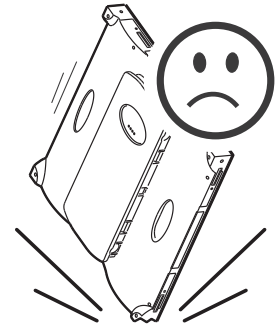

To avoid damage to the panels, it is recommended to leave the panels in the flight case until needed. Lift the panels one at a time from the flight case, using the handle on the back of the panel.

Before use

If the LED panel has been unused for over 3 days, it must be preheated before using it at normal (80% to 100%) brightness in order to avoid damage from moisture condensation in the panel.

Unused for:	Preheat at 30% to 50% brightness for:
3 to 7 days	4 to 8 hours
over 7 days	12 hours

Installation



WARNING! Risk of injury or damage to equipment.

- The LEDs on the panel are fragile. Avoid exposing front and edges of the panels to shocks.
- To avoid personal injury and damage to the panels, assembly must be performed by two persons.

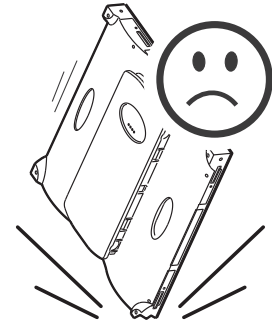

- Do not suspend more than 22* panels in each vertical column.
- When suspending more than 2 panels, a hanging boom must be used between every second unit.

*Special rigging hardware required, when rigging more than 15 panels.

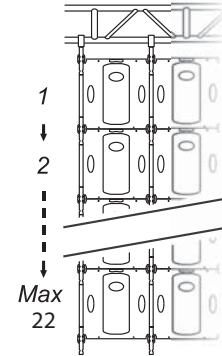

Physical rigging

When assembling a LED screen installation, mount the panels on the rigging booms one by one. Mount one row of panels at a time starting from the top and working downwards.

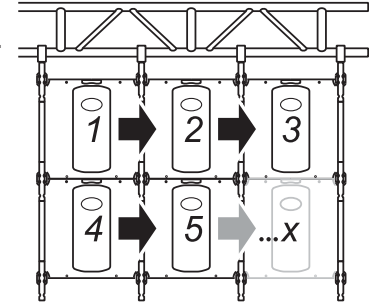

- 1 Start the rigging process by blocking the work area below and make sure the work is performed from a stable platform.
- 2 Attach the short rigging booms with the half couplers to the rigging structure.
- 3 Attach a row of long rigging booms to the short rigging booms.
- 4 Lift the first LED panel into place (for example in the top left corner) between the mounts in the rigging booms.
- 5 Fasten the panel to the rigging using the 4 bolts.

- 6 Lift an LED panel (2) into position besides the previous panel (1).
(Make sure the latches are in the open position.)
- 7 Carefully align the panels (left to right) and lock them in place by turning the 2 latches with an Allen wrench.

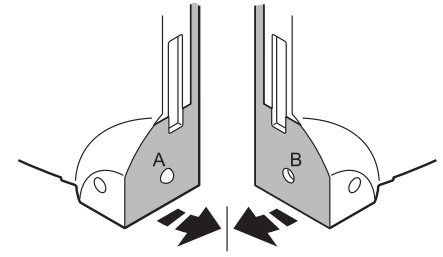

- 8 Fasten the panel to the rigging using the 4 bolts.
- 9 Repeat steps 6 to 8 to complete a full row of panels.

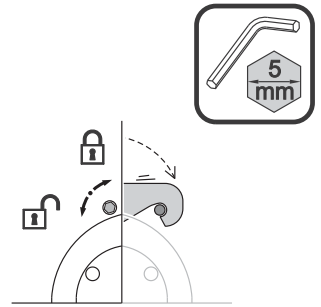

- 10 Lift an LED panel (4) into place below the first panel (1).
(Make sure the latches are in the open position.)

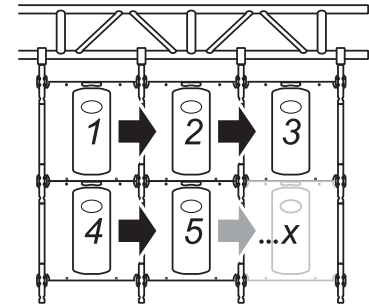

- 11 Carefully align the panels (top to bottom) and lock them in place by turning the 2 latches with an Allen wrench.
- 12 Fasten the panel to the rigging using the 4 bolts.
- 13 Repeat steps 6 to 8 to complete a full row of panels.
- 14 Attach a row of long rigging booms to the short rigging booms.
- 15 Repeat steps 10 to 13 for the rest of the rows of panels.

Signal connection

The pixel data signal is passed from the LED controller to the LED screen through the signal cable. The individual LED panels of the screen are connected in a daisy chain pattern. The LED controller must be configured to reflect the physical connection pattern. (See LED controller documentation for details.)

The signal indicator (green) on the back of the panel flashes quickly (approx. every second) when a correct signal connection is established. When no signal is detected, the indicator flashes slowly (approx. every 5 seconds).

It is highly recommended to use the same connection pattern for connect both signal and power. The following figure shows an example of the recommended signal connection pattern.

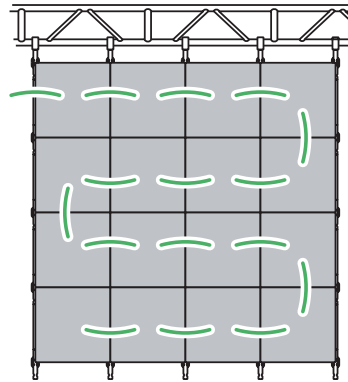

Power connection



DANGER! Risk of fire.

- Do not connect more than 16 LED panels at 240VAC / 8 LED panels at 100VAC to a single line of power.

Power is supplied to the LED panels with power link cables. Power can be passed through the panels of the screen in a daisy chain pattern. The power indicator (red) on the back of the panel is on when power connection is established.

It is highly recommended to use the same connection pattern for connect both signal and power. The following figure shows an example of the recommended signal connection pattern.

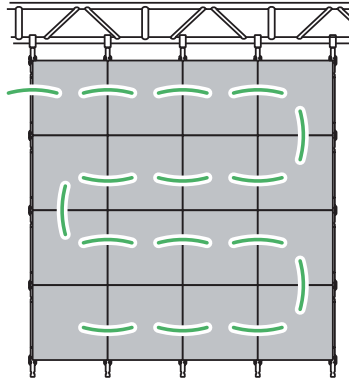

Dismantling and storage

Dismantling



WARNING! Risk of injury or damage to equipment.

- The LEDs on the panel are fragile. Avoid exposing front and edges of the panels to shocks.
- To avoid personal injury and damage to the panels, assembly must be performed by two persons.

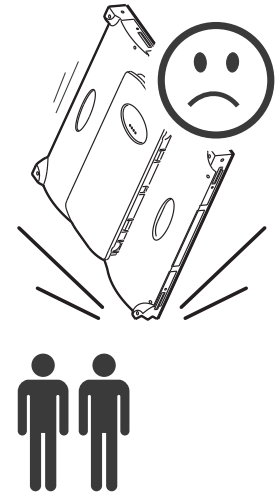

When dismantling a LED screen installation, remove the panels from the rigging booms one by one. Remove one row of panels at a time starting from the bottom and working upwards. As panels are removed from the vertical rigging booms, remove the free rigging booms.

Storage

When not in use, it is recommended to store the LED panels in the flight case. Using the handle on the back of the panel, carefully slide the panel down into an open slot in the flight case.

The LED panel must be stored in the environment with temperature less than 30°C (86°F) and humidity less than 60%.

Service and maintenance



WARNING! Read the safety precautions before performing service on this product.

There are no user-serviceable components in the device. Do not open the device, as doing so is likely to damage it. Consult your SGM dealer if the device operates abnormally, is defective or otherwise in need of service or repair.

Cleaning



CAUTION Risk of damage to equipment.

- Panels may be damaged when exposed to liquids. Do not use liquids when cleaning the panels.

To clean the LED panel, brush lightly with a soft banister brush.

Troubleshooting

Problem	Probable cause	Remedy
One or more whole LED panel is dead.	No power.	Check power and connections.
	Defective power supply.	Replace power supply.
One LED module is dead.	LED module incorrectly installed and connected.	Check LED module.
	LED module faulty.	Replace LED module.
One or more LED panels displays video incorrectly.	Incorrect signal connections.	Check signal connections.
	Incorrect LED controller configuration.	Check controller configuration.

Specifications

PHYSICAL

Dimensions (L x H x W)	480 x 480 x 80 mm (18.9 x 18.9 x 3.1 in.)
Weight (per module).....	8.5 kg (18.7 lbs.)
Weight (per sqm).....	37 kg (81.6 lbs.)
Material	Die casting aluminium
Rigging possibilities	Suspended with half coupler system
Rigging limitations	Maximum 22 panels vertical, no limitations horizontal
Temperature range (operating)	-10 to 50 °C (-14 to 122 °F)
Temperature range (start-up)	-10 to 50 °C (-14 to 122 °F)
Humidity	10-90 %RH
IP class (front/rear)	IP43/IP40
Cooling.....	Passive, no noise

OUTPUT

Pixel Pitch	3.75 mm
Light Source.....	128 x 128 pixel, 3-in-1 SMD 2121 LEDs
Total pixel per panel	16 384 pixels
Total pixel per sqm	71 111 pixels
Light output	950 cd/nits per sqm
Color temperature	6500K
LEDs expected lifetime	50 000 hours*

*(Figure provided by manufacturer and obtained under manufacturer's test conditions.)

OPTICS

Viewing angle 140° H

FEATURES

Contrast ratio 1 600:1

Refresh rate 2 880 Hz

Frame rate 60 frames / second

Grey scale 14bit

ELECTRICAL

SMPS 100 - 240 V Nominal 50/60 Hz

Typical power consumption (per panel) 54 W

Typical power consumption (per sqm) 234 W

Max. power consumption (per panel) 90 W

Max. power consumption (per sqm) 390 W

Interconnected Max. 16 panels at 240VAC / 8 panels at 100VAC

PROGRAMMING AND CONTROL

Control system Asynchronous video signal (RJ45)

Scaler input signals Composite, YUV, YC, DVI, HDMI, VGA, SDI, HDSGI, 3D HDSDI

Communication interface RD-232 / RS-422 / RS-485

CONNECTORS

Connections Neutrik power input and linkthru / RJ45 input and linkthru for data

CERTIFICATIONS

EU Safety EN60950-1
EU EMC EN55022
 EN55024
 EN61000-3-2
 EN61000-3-3



INCLUDED ITEMS

Order no.	Description
80040010	LS-3.75 LED Panel with Neutrik power connector (black front)
82050502	Flightcase for 6pcs of LS-3.75 LED panels

Specifications subject to change without further notice

Ordering information

Fixtures

Part no.	Description
80040010	LS-3.75 LED Panel with Neutrik power connector (black front)

Power cables

Part no.	Description
83062030	Power link cable 100cm with Neutrik connector
83062031	Power input cable 15m with Neutrik connector

Data cables

Part no.	Description
83062016	Data link RJ45 cable 100cm
83062017	Data link RJ45 cable 15m

Controllers

Part no.	Description
80070222	MCTRL-300 for control of up to 1.3mill pixels
80070225	MCTRL-610 for control of up to 2.3mill pixels

Extender kit for controllers

Part no.	Description
80070226	CVT320 Fibre Optic RJ45

Scaler

Part no.	Description
80070224	Scaler, VSP-550DS

Light sensor

Part no.	Description
80070227	Light sensor for MCTRL controller series

Calibration system

Part no.	Description
80070223	LS-LDC Led Display Calibration System

Rigging

Part no.	Description
83060607	Rigging Boom
83060608	Rigging Boom with halfcoupler

Flightcase

Part no.	Description
82050502	Flightcase for 6pcs of LS LED modules, Black
82050503	Flightcase for LS accessories, Grey

User's notes

SGM A/S · Sommervej 23 · 8210 Aarhus V · Denmark
Tel +45 70 20 74 00 · info@sgmlight.com · www.sgmlight.com