

SGM® P-5 WASH LIGHT
P-5 WHITE
P-5 TUNABLE WHITE

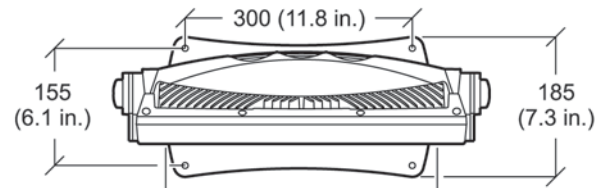

P-5 series dimensions

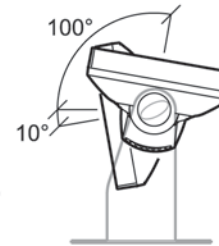
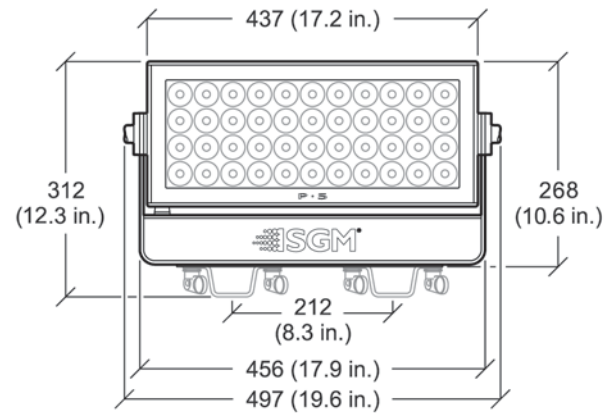
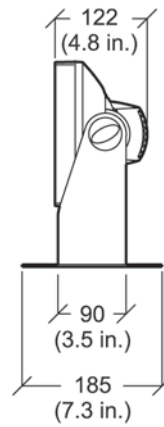

Measurements in millimetres
and inches (in brackets).
Drawing not to scale.

P-5 WASH LIGHT USER MANUAL

© 2015 SGM®. Information subject to change without notice. SGM and all affiliated companies disclaim liability for any injury, damage, direct or indirect loss, consequential or economic loss or any other loss occasioned by the use of, inability to use or reliance on the information contained in this manual. The SGM logo, the SGM name and all other trademarks in this document pertaining to services or products by SGM or its affiliates and subsidiaries are trademarks owned or licensed by SGM or its affiliates or subsidiaries.

The original edition of this document is in English. All other language editions are translations of the original edition.

This edition applies to firmware version 1.35 or later.

Ver. F

Contents

P-5 series dimensions	2
Safety information	7
Overview	10
Parts identification and terminology	11
Preparing for installation	12
Installing the P-5	13
Connecting AC Power	15
Configuring the fixture	16
<i>Configuring the fixture using an Android telephone via RFID.....</i>	<i>16</i>
<i>Master/Slave configuration</i>	<i>17</i>
Setting a static color manually	18
Using stand-alone operation	19
Connecting to a DMX control device	20
<i>Enabling the wireless cone antenna receiver</i>	<i>20</i>
<i>Attaching the W-DMX™ G4 wireless receiver</i>	<i>21</i>

Configuring the fixture for DMX control	22
<i>About DMX</i>	22
<i>Setting the DMX address</i>	22
<i>Setting the DMX mode</i>	23
<i>Full Color Calibration and Color Temperature Correction (P-5 only)</i>	25
Fixture personality settings	26
<i>Setting the dimming curve</i>	26
<i>Flipping the OLED display</i>	26
<i>Setting the OLED display saver</i>	26
<i>Setting the fan mode</i>	27
Service	28
<i>Changing lens module</i>	28
<i>Upgrading the firmware</i>	31
<i>Cleaning</i>	31
DMX protocols	32
<i>P-5 DMX Protocols</i>	32
<i>P-5 W DMX Protocols</i>	39
<i>P-5 TW DMX Protocols</i>	42
Control menu	47

Fixtures and accessories	57
<i>Included items</i>	57
<i>Ordering information</i>	57
User's notes	59

Safety information



WARNING! Read the safety precautions in this section before unpacking, installing, powering or operating this product.

The P-5 series luminaries are multi-environmental fixtures with an IP-rating of 65, intended for professional use only. They are not suitable for household use. **Impropre a l'usage domestique.**

Review the following safety precautions carefully before installing or operating the fixture. This fixture must be installed in accordance with the applicable installation code by a person familiar with the construction and operation of the fixture and the hazards involved. **Ce produit doit être installé selon le code d'installation pertinent, par une personne qui connaît bien le produit et son fonctionnement ainsi que les risques inhérent.**

Preventing electric shock



WARNING! Risk of electric shock.

- Always power off/unplug the fixture before removing any covers.
- Ensure that the power is turned off when connecting the fixture to the AC mains supply.
- Ensure that the fixture is electrically connected to earth (ground).
- Do not apply power if the fixture is in any way damaged.
- Do not immerse the fixture in water or liquid.

Preventing burns and fire



WARNING! Take measures to prevent burns and fire.

- Install in a location that prevents accidental contact with the fixture.
- Install only in a well-ventilated space.
- Install at least 0.3 m (12 in.) away from objects to be illuminated.
- Install only in accordance with applicable building codes.
- Ensure a minimum clearance of 0.1 m (4 in.) around the cooling fans.
- Do not paint, cover or modify the fixture.
- Keep all flammable materials away from the fixture.
- Allow the fixture to cool for 15 minutes after operation, before touching it.

CAUTION: *Exterior surface temperature after 5 min. operation = 45 °C (113 °F). Steady state = 68 °C (154 °F).*

Avoid personal injury



WARNING! *Take measure to prevent personal injury.*

- Do not look directly at the light source from close range.
- Take precautions to prevent injury due to falls when working at height.
- For permanent installation, ensure that the fixture is securely fastened to a load-bearing surface with suitable corrosion-resistant hardware.
- For temporary installation with clamps, ensure that the quarter-turn fasteners are turned fully and secured with a suitable safety cable. The cable must be approved for a safe working load (SWL) of 10 times the weight of the fixture, and it must have a minimum gauge of 3 mm.

Overview

P-5, P-5 W (white) and P-5 TW (tunable white) luminaries are DMX-controllable, low-profile, IP65-rated, rectangular, LED wash lights. The standard P-5 offers full RGBW color mixing, color temperature control and incorporate 44 10 W RGBW Cool White Emitter LED's. The P-5 W is similar, but incorporating white-emitting LEDs.

The P-5 TW offers the ability to adjust white color temperature to 2200, 3000, 4000 or 5300K. The P-5's all provide built-in wireless DMX support, stand-alone programs, dimming, and a lamp life expectancy of 50,000 hours*. The P-5's also offer a variation of beam angles with 15°, 21° or 43° interchangeable lenses.

This manual covers installation, use and maintenance of the P-5. All documentation is also available from the SGM web-site: <http://www.sgmlight.com>

* At 70% of luminous output under the manufacturer's test conditions.

Parts identification and terminology

- A 44 x 10 W LEDs
- B Base
- C Safety wire eyelet
- D Cooling fans
- E Tilt lock
- F DMX in and out
- G Wireless antenna socket
- H OLED display
- I Control panel
- J Power connections
- K Tilt lock

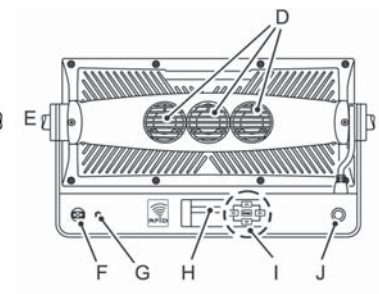
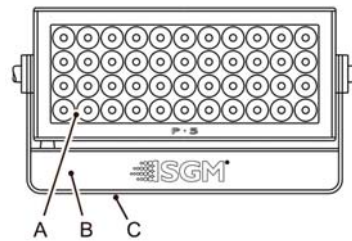

Preparing for installation

Unpack the fixture and inspect it to ensure that it has not been damaged during transport.

The P-5 is shipped with two quarter-turn brackets, that can be used to mount the fixture at elevation, and a W-DMX™ G4 wireless antenna.

. The fixture is IP65-rated, and is designed for use in wet locations. This means that it is protected from:

- Dust, to the degree that dust cannot enter the fixture in sufficient quantities as to interfere with its operation.
- Lower pressure jets of water from any direction.

When selecting a location for the fixture, ensure that:

- It is situated away from public thoroughfares and protected from contact with people.
- It is not immersed in water or exposed to high-pressure water jets.
- It has adequate ventilation.

Installing the P-5

The P-5 may be installed in any orientation, but if installed horizontally with a downward beam-angle, water can potentially pool in the fan wells. Under normal operation the moisture will evaporate. However, in locations with high rainfall, you may wish to fabricate a rain shield above the fixture, or modify the position and orientation of the fixture to minimize pooling.

For permanent installation on the ground, remove the rubber feet from the floor stand/base. Fasten securely through the resulting holes with four 6 mm (1/4 in.) corrosion-resistant mechanical fasteners suitable for the location.

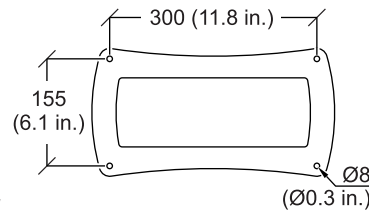

Dimensions in millimeters and inches.

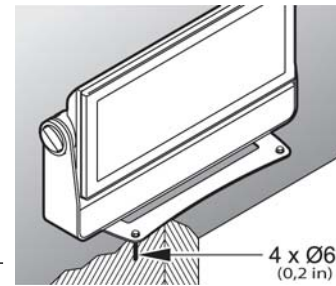

Two quarter-turn brackets are supplied with the fixture if it is to be flown above the ground. Remove the floor stand/base and rig the P-5 to a support truss or structure using the supplied brackets and suitable clamps.



Fasten a safety cable (not shown) between the support structure and the attachment point on the fixture. The safety cable must be able to bear at least 10 times the weight of the fixture.

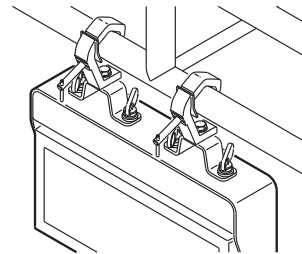

WARNING! Always secure an elevated P-5 with a safety cable as backup.

The fixture can be tilted from 0° - 180°. To adjust the tilt angle, loosen the two tilt screws, one of each side of the fixture, tilt the fixture to the angle required and re-tighten the screws.

CAUTION: If the fixture has been operating, always allow it to cool for 15 minutes before handling.

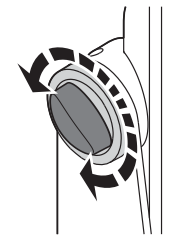

Connecting AC Power

The P-5 can operate on any 208–240 V, 50/60 Hz AC mains power supply. It draws approximately 2 amps at full power.

For permanent installation, have a qualified electrician wire the mains cable directly to a suitable branch circuit. The junction's ingress protection (IP) rating must be suitable for the location.

For temporary installation, the mains cable may be fitted with a grounded connector intended for exterior use.

The power cable color coding is given in Table 1-1.

- Connect the black wire to live
- Connect the white wire to neutral
- Connect the green/yellow wire to ground (earth)



<i>Wire</i>	<i>Color</i>	<i>Symbol</i>	<i>Conductor</i>
	Black	L	live
	White	N	neutral
	green/yellow	\perp or \oplus	ground (earth)

Table 1-1

The fixture must be grounded/earthed and be able to be isolated from AC power. The AC power supply must incorporate a fuse or circuit breaker for fault protection.

After connecting the P-5 to power, run the on-board test, using the "Test→Automated test" menu, to ensure that the fixture and each LED are functioning correctly. See "Control menu" on page 47.

CAUTION: Do not open the fixture to replace the supplied power cable, or connect the fixture to an electrical dimmer system, as this can damage it.

Configuring the fixture

Set up the fixture using the control panel and OLED display at the top of the fixture.

Navigate the menus and options using the arrow buttons and select items using the Enter button. The options available are listed in "Control menu" on page 47.

After powering the P-5 on, the display shows the currently selected operating mode and other information.

A - Operational mode (Quick color, stand-alone or DMX mode)

B - DMX address

C - External data indicator (if DMX control is active)

D - External data protocol (W-DMX™ or DMX)

The fixture is set by default to be controlled in DMX mode.

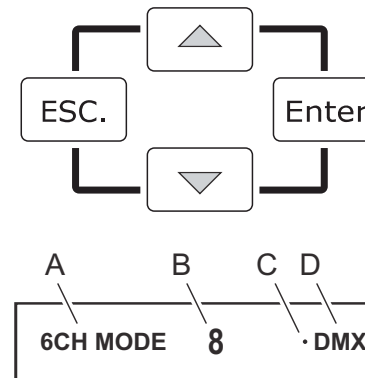

Configuring the fixture using an Android telephone via RFID

P-5 fixtures can also be configured wirelessly, via RFID, using the SGM Tool app installed on an Android smart phone that has NFC support (ISO 15693 and ISO 18000-3 mode 1 compatible, operating on 13.56 MHz \pm 7k Hz carrier frequency).

Master/Slave configuration

You can set a P-5 fixture to operate as master fixture to another P-5 fixture (which then becomes a slave fixture), or an entire group of P-5 fixtures (which then becomes slave fixtures). The assigned slave fixture(s) will mimic the settings of the master fixture. Use the "Manual→Master/Slave" menu to set your fixture as master fixture or slave fixture.

Setting a static color manually

The fixture can be configured to display a predefined and static color using the “Manual→Quick color” menus (see “Control menu” on page 31).

Note that whenever the “Manual→Quick color” settings are changed, the fixture will be set by default to automatically start in quick color mode whenever it is powered on. This can be reset using the “Settings→Startup mode→Select startup mode” (see “Control menu” on page 47).

Using stand-alone operation

Stand-alone operation is where the fixture is not connected to a control device, but is preprogrammed with a series of up to 24 scenes, that play continuously in a loop. Up to three stand-alone programs can be defined and run from the menus, and one of the programs can be set to run by default whenever the fixture is started.

Each of the three available stand-alone programs contains 24 user-definable scenes, each scene with its own RGBW (or white) and shutter settings. Each scene has a definable fade-in time, for the transition from one color (or white) to the next, and a wait (static) time, each of up to 999 minutes and 59 seconds in duration. To define a stand-alone program, use the “Manual→Editor” menus (see “Control menu” on page 47).

Stand-alone mode at fixture startup is enabled using the “Settings→Startup mode→Select startup mode→Standalone” menu. The program to be run is selected using “Settings→Startup mode→Startup program” menu (see “Control menu” on page 47) for a description of the menus). The chosen program will run its length cyclically whenever the fixture is powered on.

A program can be run at any time by selecting it using the “Manual→Run program” menu.

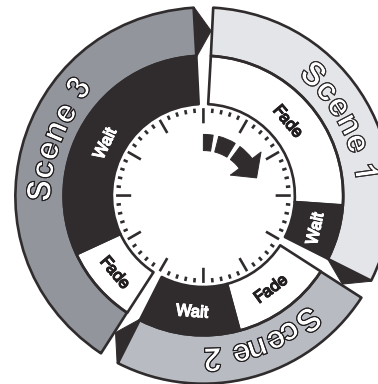

Connecting to a DMX control device

The fixture is controllable using a DMX control device and it can be connected using either a DMX cable or via the P-5's built-in wireless receiver system.

If using a cabled DMX system, connect the DMX in cable (with male 5-pin XLR plug) and out cable (with female 5-pin XLR plug) to the DMX data link. Terminate the DMX out cable of the last fixture in the data link. For outdoor installations, use only IP-rated XLR connectors suitable for outdoor use.

Enabling the wireless cone antenna receiver

The wireless cone antenna is factory mounted and is recommended for short-range wireless operation. For long range wireless operation, the W-DMX™ G4 wireless receiver is recommended (see details below).

Before you enable the wireless cone antenna, ensure that there is no DMX cable connected to the fixture.

Use the “Settings→Wireless DMX→Enable” menu to enable wireless DMX and the “Settings→Wireless DMX→Wireless LED Status” to confirm that a data connection has been established. The wireless cone antenna operates at a frequency of 2.4 GHz, so ensure that the DMX transmitter is configured to operate in this range.

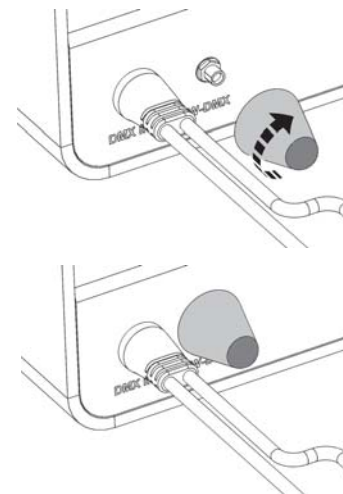

Attaching the W-DMX™ G4 wireless receiver

The W-DMX™ G4 wireless receiver is an included accessory and is recommended for long-range wireless operation.

Before you connect the wireless receiver, ensure that there is no DMX cable connected to the fixture. Attach the supplied wireless DMX antenna to the connector on the back of the fixture.

Use the “Settings→Wireless DMX→Enable” menu to activate wireless DMX and the “Settings→Wireless DMX→Wireless LED Status” to confirm that a data connection has been established. W-DMX™ G4 operates at a frequency of 2.4 GHz, so ensure that the DMX transmitter is configured to operate in this range.

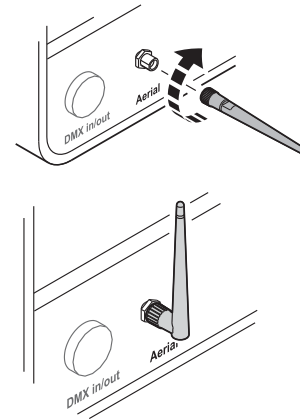

Configuring the fixture for DMX control

About DMX

The P-5 can be controlled using signals sent by a DMX controller on a number of channels (which varies depending on the DMX mode that has been set).

The first channel used to receive data from a DMX control device is known as the DMX start address. Each P-5 must have a DMX start address set. For example, if a P-5 has a DMX address of 10 and it is in 3-channel DMX mode, then it uses channels 10, 11, and 12. The following fixture in the DMX chain could then be set to a DMX address of 13. If two or more DMX fixtures of the same type have the same DMX address, then they will mimic each other's behavior. Incorrect settings will result in unpredictable responses to the lighting controller.

Setting the DMX address

The DMX address can be seen on the OLED display. To change the address setting, press the up and down arrows. When the desired address is displayed, press 'Enter' to save the setting. For your convenience, the suggested DMX address of the next fixture is displayed to the right. Note that channel spacing is determined by the DMX mode.

See the "DMX protocols" on page 32 for specific DMX control values.

SET DMX ADR	10	NEXT FIX
		13

Setting the DMX mode

Using the “DMX mode” menu available from the control panel, specify the DMX mode that provides the fixture controls that you require:

P-5 DMX modes	Function
3	Individual control of color channels for red, green & blue. White is automatically mixed in.
4	Individual control of color channels for red, green, blue and white (RGBW).
6	RGBW, intensity, shutter, strobe, pulse & open shutter effects.
8	RGBW with fine control of individual colors.
9	Intensity and RGBW, with fine control of individual colors.
10	Intensity and RGBW, with fine control.

P-5 TW DMX modes	Function
2	Intensity & white temperature control (2200k-5300K)
4	White temperature control (2200K, 3000K, 4000K, and 5300K)
6	Intensity, white temperature control (2200K, 3000K, 4000K, and 5300K), shutter, strobe, pulse and open shutter effects.
8	Fine and coarse control of white temperatures (2200K, 3000K, 4000K, and 5300K)

P-5 W DMX modes	Function
1	Intensity
2	Intensity, shutter, strobe, pulse & open shutter effects.
2 (16 bit)	Fine and coarse intensity

Full Color Calibration and Color Temperature Correction (P-5 only)

All channel modes except 3 Channel Mode RGB: Lets you choose between raw or white-calibrated color (6500K default) via the Control Menu ("Settings→White Calibrated")

3 Channel Mode RGB: Features full color calibration (irrespective of current color setting) when you mix 2 or 3 colors to ensure uniform color between products. Adjusting 1 color does not activate full color calibration.

If you want to be able to mix raw RGB colors without full color calibration, select the 4 Channel Mode RGBW and disregard the white color.

All channel modes except 3 Channel Mode RGB	3 Channel Mode RGB
Choose raw or white-calibrated color (6500K default) via the Control Menu ("Settings→White Calibrated")	Full Color Calibration

Fixture personality settings

Setting the dimming curve

The setting of the dimming curve will determine the fixture's behavior, when changing the light intensity between 0% - 100%. Linear control provides uniform adjustment throughout the control action, whereas gamma corrected dimming provides finer control at low light levels, where the eye is more sensitive to change. By default, the P-5 uses gamma corrected dimming. For uniform response, set all fixtures to the same dimming curve. To set the desired dimming curve, use the "Settings→Dimming curve" menu.

Flipping the OLED display

If the fixture is installed hanging upside down, it might be useful to flip the display so that it is easier to read. To flip the display, use the "Settings→Flip display" menu, or press the up and down buttons on the control panel at the same time.

Setting the OLED display saver

By default the OLED display dims down after a short period when the control panel is not in use, but it can also be set to turn off completely. Pressing any key will always turn on the display or restore it to normal brightness. To change the display saver, use the "Settings→Display saver" menu.

NOTE: To avoid the risk of display deterioration caused by long term use in permanent installations, it is recommended to use the "Display saver→Display off" setting.

Setting the fan mode

For operating environments where low-noise is a requirement or where the fixture will be operating in high temperatures, it is possible to adjust the default fan speed to low or high using the “Settings→Fan mode” menu.

Service

Apart from the lens module, there are no user-serviceable components in the fixture. Do not open the P-5, as doing so is likely to damage the ingress protection. Consult your SGM dealer if the fixture operates abnormally, is defective or otherwise in need of service or repair.

Changing lens module

To replace the lens module:

- 1 Unscrew the highlighted screws with a TX20 screwdriver.

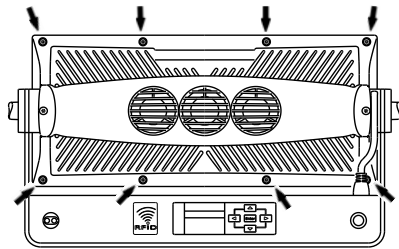

- 2 Dismantle the front and unscrew the highlighted front plugs with an Unbrako 6/HOP6 Allen key.

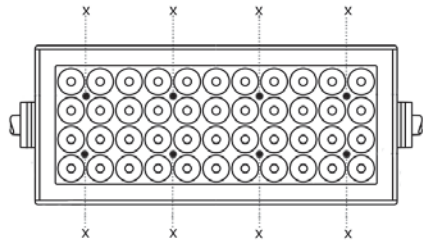

- 3 Take out the lens module.
- 4 Place the new lens on the PCB print spacers and carefully press the lens module in place.

- 5 Screw in the highlighted front plugs with an Unbrako 6/HOP6 Allen key (Nm 1,0) and place three Silica Gel bags (not included in lens kit) as shown.

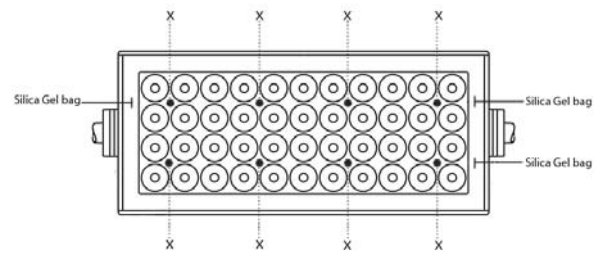

- 6 Place the sealing frame (facing upwards - see below) on top of the lens module.

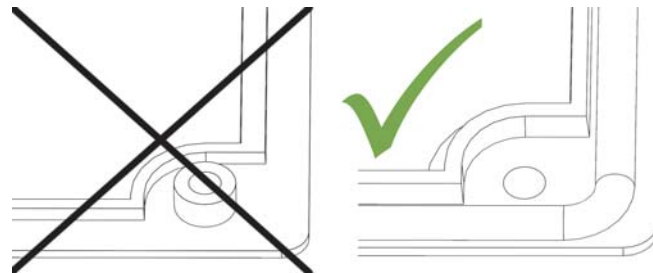

- 7 Place Front Assembly on top of the sealing frame.
- 8 Screw in the highlighted screws with a TX20 screwdriver (Nm 0,7) (see step 1).
- 9 Check that the sealing frame is evenly visible all the way around the lens module.

Upgrading the firmware

The firmware installed on the fixture can be identified using the “Info→Firmware version” menu. We recommend that you keep your fixture’s firmware up-to-date. Visit <http://www.sgmlight.com> to download the latest firmware.

To perform firmware updates, you need a Windows-based personal computer and a SGM USB 5-Pin-XLR upload cable (available from your SGM distributor).

Cleaning

To maintain optimal performance, regular cleaning is essential. Cleaning schedules will vary depending on the operating environment, and the installation should therefore be checked at frequent intervals within the first few weeks of operation to see whether cleaning is necessary. This procedure will allow you to assess cleaning requirements in your particular situation. If in doubt, consult your SGM dealer for a suitable maintenance schedule.

Clean the P-5 using a soft cloth dampened with a solution of water and a mild detergent. Do not use products that contain solvents, abrasives or caustic agents for cleaning, as they can cause damage to both hardware, cables and connectors.

DMX protocols

Configuring DMX is described "Setting the DMX mode" on page 23.

P-5 DMX Protocols

3 Channel Mode - RGB plus automatic White

Channel	Name	DMX value	DMX percentage	Description	Info	Default DMX value	Fader type
1	RED	0 255	0,0% 100,0%	No RED > Maximum RED	-	0 (0%)	Fade
2	GREEN	0 255	0,0% 100,0%	No GREEN > Maximum GREEN	-	0 (0%)	Fade
3	BLUE	0 255	0,0% 100,0%	No BLUE > Maximum BLUE	-	0 (0%)	Fade

4 Channel Mode - RGBW (Raw mode)

Channel	Name	DMX value	DMX percentage	Description	Info	Default DMX value	Fader type
1	RED	0 255	0,0% 100,0%	No RED > Maximum RED	-	0 (0%)	Fade
2	GREEN	0 255	0,0% 100,0%	No GREEN > Maximum GREEN	-	0 (0%)	Fade
3	BLUE	0 255	0,0% 100,0%	No BLUE > Maximum BLUE	-	0 (0%)	Fade
4	WHITE	0 255	0,0% 100,0%	No WHITE > Maximum WHITE	-	0 (0%)	Fade

6 Channel Mode - RGBW plus Shutter (Raw mode)

Channel	Name	DMX value	DMX percentage	Description	Info	Default DMX value	Fader type
1	Shutter	0 7	0,0% 2,7%	Closed		10 (3,9%)	Snap
		8 15	3,1% 5,9%	Open			
		16 151	6,3% 59,2%	Strobe	Fast > Slow		
		152 175	59,6% 68,6%	Pulse - Open	Slow > Fast		
		176 199	69,0% 78,0%	Pulse - Close	Slow > Fast		
		200 244	78,4% 95,7%	Strobe - Random	Slow > Fast		
		245 255	96,1% 100,0%	Open			
2	Intensity	0 255	0,0% 100,0%	No light > Maximum light		0 (0%)	Fade
3	RED	0 255	0,0% 100,0%	No RED > Maximum RED	-	0 (0%)	Fade
4	GREEN	0 255	0,0% 100,0%	No GREEN > Maximum GREEN	-	0 (0%)	Fade

Channel	Name	DMX value	DMX percentage	Description	Info	Default DMX value	Fader type
5	BLUE	0 255	0,0% 100,0%	No BLUE > Maximum BLUE	-	0 (0%)	Fade
6	WHITE	0 255	0,0% 100,0%	No WHITE > Maximum WHITE	-	0 (0%)	Fade

8 Channel Mode (16 bit) - RGBW

Channel	Name	DMX value	DMX percentage	Description	Info	Default DMX value	Fader type
1 2	RED	0 65535	0,0% 100,0%	No RED > Maximum RED	-	0 (0%)	Fade
3 4	GREEN	0 65535	0,0% 100,0%	No GREEN > Maximum GREEN	-	0 (0%)	Fade
5 6	BLUE	0 65535	0,0% 100,0%	No BLUE > Maximum BLUE	-	0 (0%)	Fade
7 8	WHITE	0 65535	0,0% 100,0%	No WHITE > Maximum WHITE	-	0 (0%)	Fade

9 Channel Mode (16 bit) - Intensity & RGBW

Channel	Name	DMX value	DMX percentage	Description	Info	Default DMX value	Fader type
1	Intensity	0 255	0,0% 100,0%	No light > Maximum light	-	0 (0%)	Fade
2 3	RED	0 65535	0,0% 100,0%	No RED > Maximum RED	-	0 (0%)	Fade
4 5	GREEN	0 65535	0,0% 100,0%	No GREEN > Maximum GREEN	-	0 (0%)	Fade
6 7	BLUE	0 65535	0,0% 100,0%	No BLUE > Maximum BLUE	-	0 (0%)	Fade
8 9	WHITE	0 65535	0,0% 100,0%	No WHITE > Maximum WHITE	-	0 (0%)	Fade

10 Channel Mode (16 bit) - Intensity & RGBW

Channel	Name	DMX value	DMX percentage	Description	Info	Default DMX value	Fader type
1 2	Intensity	0 65535	0,0% 100,0%	No light > Maximum light	-	0 (0%)	Fade
3 4	RED	0 65535	0,0% 100,0%	No RED > Maximum RED	-	0 (0%)	Fade
5 6	GREEN	0 65535	0,0% 100,0%	No GREEN > Maximum GREEN	-	0 (0%)	Fade
7 8	BLUE	0 65535	0,0% 100,0%	No BLUE > Maximum BLUE	-	0 (0%)	Fade
9 10	WHITE	0 65535	0,0% 100,0%	No WHITE > Maximum WHITE	-	0 (0%)	Fade

P-5 W DMX Protocols

1 Channel Mode - Intensity

Channel	Name	DMX value	DMX percentage	Description	Info	Default DMX value	Fader type
1	WHITE	0 255	0,0% 100,0%	No WHITE > Maximum WHITE	-	0 (0%)	Fade

2 Channel Mode - Shutter & Intensity

Channel	Name	DMX value		DMX percentage		Description	Info	Default DMX value	Fader type
1	Shutter	0	7	0,0%	2,7%	Closed		10 (3,9%)	Snap
		8	15	3,1%	5,9%	Open			
		16	151	6,3%	59,2%	Strobe	Fast > Slow		
		152	175	59,6%	68,6%	Pulse - Open	Slow > Fast		
		176	199	69,0%	78,0%	Pulse - Close	Slow > Fast		
		200	244	78,4%	95,7%	Strobe - Random	Slow > Fast		
		245	255	96,1%	100,0%	Open			
2	WHITE	0	255	0,0%	100,0%	No WHITE > Maximum WHITE	-	0 (0%)	Fade

2 Channel Mode (16 bit) - Intensity

Channel	Name	DMX value	DMX percentage	Description	Info	Default DMX value	Fader type
1 2	WHITE	0 65535	0,0% 100,0%	No WHITE > Maximum WHITE	-	0 (0%)	Fade

P-5 TW DMX Protocols

2 Channel Mode - Intensity with CTC

Channel	Name	DMX value	DMX percentage	Description	Info	Default DMX value	Fader type
1	Intensity	0 255	0,0% 100,0%	No light > Maximum light	-	0 (0%)	Fade
2	CTC	0 255	0,0% 100,0%	2200K-5300K	-	0 (0%)	Fade

4 Channel Mode - White control (Raw mode)

Channel	Name	DMX value	DMX percentage	Description	Info	Default DMX value	Fader type
1	2200K WHITE	0 255	0,0% 100,0%	No WHITE > Maximum WHITE	-	0 (0%)	Fade
2	3000K WHITE	0 255	0,0% 100,0%	No WHITE > Maximum WHITE	-	0 (0%)	Fade

Channel	Name	DMX value	DMX percentage	Description	Info	Default DMX value	Fader type
3	4000K WHITE	0 255	0,0% 100,0%	No WHITE > Maximum WHITE	-	0 (0%)	Fade
4	5300K WHITE	0 255	0,0% 100,0%	No WHITE > Maximum WHITE	-	0 (0%)	Fade

6 Channel Mode - Shutter, Intensity & White control (Raw mode)

Channel	Name	DMX value	DMX percentage	Description	Info	Default DMX value	Fader type		
1	Shutter	0	7	0,0%	2,7%	Closed		10 (3,9%)	Snap
		8	15	3,1%	5,9%	Open		0 (0%)	
		16	151	6,3%	59,2%	Strobe	Fast > Slow	0 (0%)	
		152	175	59,6%	68,6%	Pulse - Open	Slow > Fast	0 (0%)	
		176	199	69,0%	78,0%	Pulse - Close	Slow > Fast	0 (0%)	
		200	244	78,4%	95,7%	Strobe - Random	Slow > Fast	0 (0%)	
		245	255	96,1%	100,0%	Open		0 (0%)	
2	Intensity	0	255	0,0%	100,0%	No light > Maximum light	-	0 (0%)	Fade
3	2200K WHITE	0	255	0,0%	100,0%	No WHITE > Maximum WHITE	-	0 (0%)	Fade

Channel	Name	DMX value	DMX percentage	Description	Info	Default DMX value	Fader type
4	3000K WHITE	0 255	0,0% 100,0%	No WHITE > Maximum WHITE	-	0 (0%)	Fade
5	4000K WHITE	0 255	0,0% 100,0%	No WHITE > Maximum WHITE	-	0 (0%)	Fade
6	5300K WHITE	0 255	0,0% 100,0%	No WHITE > Maximum WHITE	-	0 (0%)	Fade

8 Channel Mode (16 bit) - White control (Raw mode)

Channel	Name	DMX value	DMX percentage	Description	Info	Default DMX value	Fader type
1 2	2200K WHITE	0 65535	0,0% 100,0%	No WHITE > Maximum WHITE	-	0 (0%)	Fade
3 4	3000K WHITE	0 65535	0,0% 100,0%	No WHITE > Maximum WHITE	-	0 (0%)	Fade

Channel	Name	DMX value	DMX percentage	Description	Info	Default DMX value	Fader type
5 6	4000 WHITE	0 65535	0,0% 100,0%	No WHITE > Maximum WHITE	-	0 (0%)	Fade
7 8	5300 WHITE	0 65535	0,0% 100,0%	No WHITE > Maximum WHITE	-	0 (0%)	Fade

Control menu

Level 1	Level 2	Level 3	Function
Mode	Select Mode	-	Select DMX mode. See "Setting the DMX mode" on page 23 for information about the features of each mode.
Info	Product Type	-	Displays product type.
	Firmware Version	-	Displays installed software version.
	Serial Number	-	Displays serial number.
	RDM ID	-	Displays RDM ID (for use with the SGM Tool App).
	DMX View	-	Displays received DMX levels.
	Temperatures MB: LED:	-	Displays fixture temperatures (Mainboard and LED panel)
	Power On Time	-	Displays power on time
	Power On Time Resettable	-	

Level 1	Level 2	Level 3	Function
Info (continued)	LED On Time R: G: B: W:	-	Displays LED on time (Red, Green, Blue, and White)
	LED On Time Resettable R: G: B: W:	-	
	Log	-	Displays recorded operating data and error codes.
	Debug	-	Service use only.
Settings	Wireless DMX	Log Off	Sends log off command to W-DMX system.
		Wireless LED	Flashing - not connected to data. Solid - connected to data.
		Enable	Enables wireless DMX operation.
		Disable	Disables wireless DMX operation.
		Wireless DMX out enable	Enables wireless DMX out operation.

Level 1	Level 2	Level 3	Function
Settings (continued)	Wireless DMX (continued)	Wireless DMX out disable	Disables wireless DMX out operation.
	Startup Mode	Select Startup Mode	Default operating mode when fixture is powered on: 1. Quick Color 2. Stand-alone 3. DMX (factory default)
		Startup Program	Stand-alone program 1, 2, or 3. Only used if the startup mode is set to "stand-alone". 1 is default.
	Dimming Curve	Linear	Provides equal resolution dimming from 0-100%
		Gamma Corrected	Provides high-resolution dimming at low levels.
	White Calibrated	Calibrated	Enables white calibrated color.
		Raw	Enables raw color.
	Flip Display	Disable	Selects normal control panel display.

Level 1	Level 2	Level 3	Function
Settings (continued)	Flip Display (continued)	Enable	Flips control panel display.
	Display Saver	Display Dim	Dims the OLED display when the control panel is not in use.
		Display Off	Turns off the OLED display when the control panel is not in use.
	Fan Mode	Standard	Adjust fan speed relative to internal fixture temperature.
		Silent	Low fan speed for quiet operation.
		Max Power	High fan speed for maximum cooling effect.
		Always Full Power	High fan speed with no adjustment.
	Minimum values	Min. Red (P-5)	Adjust default minimum setting (0-1000).
		Min. Green (P-5)	
		Min. Blue (P-5)	

Level 1	Level 2	Level 3	Function
Settings (continued)	Minimum values (continued)	Min. White (P-5)	
		Min. Line 1 (P-5 W)	
		Min. Line 2 (P-5 W)	
		Min. Line 3 (P-5 W)	
		Min. Line 4 (P-5 W)	
		Min. 3000 (P-5 TW)	
		Min. 2200 (P-5 TW)	

Level 1	Level 2	Level 3	Function
Settings (continued)	Minimum values (continued)	Min. 4000 (P-5 TW)	
		Min. 5300 (P-5 TW)	
	RFID Write	-	
	Refresh Rate	-	
	Factory Default	-	Reset the fixture to factory default settings.
	Service Pin	-	
	Service Menu	-	
Manual	Quick Color	Red (P-5)	Static quick color - red mix (0-255). Sets fixture to quick color startup mode.
		Green (P-5)	Static quick color - green mix (0-255). Sets fixture to quick color startup mode.

Level 1	Level 2	Level 3	Function
Manual (continued)	Quick Color (continued)	Blue (P-5)	Static quick color - blue mix (0-255). Sets fixture to quick color startup mode.
		White (P-5/ P-5 W)	Static quick color - white mix (0-255). Sets fixture to quick color startup mode.
		2200K (P-5 TW)	Static quick color - white temperature 2200K mix (0-255). Sets fixture to quick color startup mode.
		3000K (P-5 TW)	Static quick color - white temperature 3000K mix (0-255). Sets fixture to quick color startup mode.
		4000K (P-5 TW)	Static quick color - white temperature 4000K mix (0-255). Sets fixture to quick color startup mode.
		5300K (P-5 TW)	Static quick color - white temperature 5300K mix (0-255). Sets fixture to quick color startup mode.
	Run Program	1, 2, or 3	
	Stop Program	-	

Level 1	Level 2	Level 3	Function
Manual (continued)	Master/Slave	-	Sets fixture to operate as Master or Slave fixture.
	Editor	Program	Currently selected program (1, 2, or 3).
		Scene	Currently selected scene (1-24).
		Red (P-5)	Red value in currently selected scene (0-255).
		Green (P-5)	Green value in currently selected scene (0-255).
		Blue (P-5)	Blue value in currently selected scene (0-255).
		White (P-5 / P-5 W)	White value in currently selected scene (0-255).
		2200K (P-5 TW)	2200K white temperature value in currently selected scene (0-255).
		3000K (P-5 TW)	3000K white temperature value in currently selected scene (0-255).
4000K (P-5 TW)	4000K white temperature value in currently selected scene (0-255).		

Level 1	Level 2	Level 3	Function
Manual (continued)	Editor (continued)	5300 (P-5 TW)	5300K white temperature value in currently selected scene (0-255).
		Shutter	Shutter setting in currently selected scene (0-255):
			Shutter Blackout (0-7)
			Shutter Open (8-15)
			Variable Strobe (16-151)
			Pulse Open (152-175)
			Pulse Close (176-199)
			Variable Random Strobe (200-244)
			Shutter Open (245-255)
		Fade Time (Min.)	Fade-in (transition) time to current scene in min. (0-999).
		Fade Time (Sec.)	Fade-in (transition) time to current scene in sec. (0-59).
Wait Time (Min.)	Wait (static) time in current scene in min. (0-999).		

Level 1	Level 2	Level 3	Function
Manual (continued)	Editor (continued)	Wait Time (Sec.)	Wait (static) time in current scene in sec. (0-59).
Test	Off	-	Stops test sequence execution.
	Automated Test	-	Initiates a self-test sequence.
	Burn-in Test (30 min.)	-	Service use only.
	Display Test	-	Service use only.

Fixtures and accessories

Included items

Floor stand (including screws)
Two Omega brackets
Wireless DMX™ G4 antenna
User manual
Neoprene pouch

Ordering information

P-5 Wash Light (43°)	Order no: 80030507
P-5 Wash Light (21°)	Order no: 80030501
P-5 Wash Light (15°)	Order no: 80030508
P-5 Lens Kit (43°)	Order no: 83061104
P-5 Lens Kit (21°)	Order no: 83061103
P-5 Lens Kit (15°)	Order no: 83061102
BBC-2 Dual Bracket	Order no: 83060603
BBC-4 Quad Bracket	Order no: 83060604
Floor Stand for P, Q, and X series with 1/4-turn fasteners	Order no: 83060610
Accessory Holder (P-series)	Order no: 83061119
Barn door 4-way	Order no: 83061120
Barn door 8-way	Order no: 83061121
Barn door color frame	Order no: 83061122
SGM USB uploader cable	Order no: 83062011
Flight case (for 4 fixtures - P-5/Q-7/X-5)	Order no: 82051501

APPROVALS AND CERTIFICATIONS

Certified to CSA Std. C22.2 No. 166
Conforms to UL Std. 1573
Conforms to 2006/95/EC: Low Voltage Directive
Conforms to 2011/65/EU: RoHS2 Directive



The information in this document is subject to change without notice

User's notes



SGM A/S · Sommervej 23 · 8210 Aarhus V · Denmark
Tel +45 70 20 74 00 · info@sgmlight.com · www.sgmlight.com